



CITY of NOVI CITY COUNCIL

Agenda Item J
March 26, 2018

SUBJECT: Acceptance of a Warranty Deed for additional right-of-way along Meadowbrook Road and acceptance of a sidewalk easement as part of the South University site (formerly known as Meadowbrook Office Building) located on the west side of Meadowbrook Road and south of Twelve Mile Road (Parcel 22-14-200-045).

SUBMITTING DEPARTMENT: Department of Public Services, Engineering Division

CITY MANAGER APPROVAL: 

BACKGROUND INFORMATION:

Approximately 8 years ago, HEFCO Meadowbrook Office Building, LLC was the developer of the Meadowbrook Office Building site, currently South University, located on the west side of Meadowbrook Road and south of Twelve Mile Road. The developer was offering the donation of a master planned 60-foot width right-of-way for Meadowbrook Road and a sidewalk easement for sidewalk outside of the Meadowbrook Road right-of-way, as approved on the Meadowbrook Office Building site plan. Unfortunately, the documents were inadvertently misfiled and never presented for City Council approval at that time.

The warranty deed for the additional right-of-way along Meadowbrook Road dedicates a 60-foot width master planned right-of-way for Meadowbrook Road along the frontage of the South University site. The sidewalk easement includes the portions of the constructed sidewalk that are located outside of the proposed Meadowbrook Road right-of way.

The enclosed warranty deed and easement have been favorably reviewed by the City Attorney (Beth Kudla, November 11, 2009) and are recommended for approval.

RECOMMENDED ACTION: Acceptance of a Warranty Deed for additional right-of-way along Meadowbrook Road and acceptance of a sidewalk easement as part of the South University site (formerly known as Meadowbrook Office Building) located on the west side of Meadowbrook Road and south of Twelve Mile Road (Parcel 22-14-200-045).

South University

Location Map

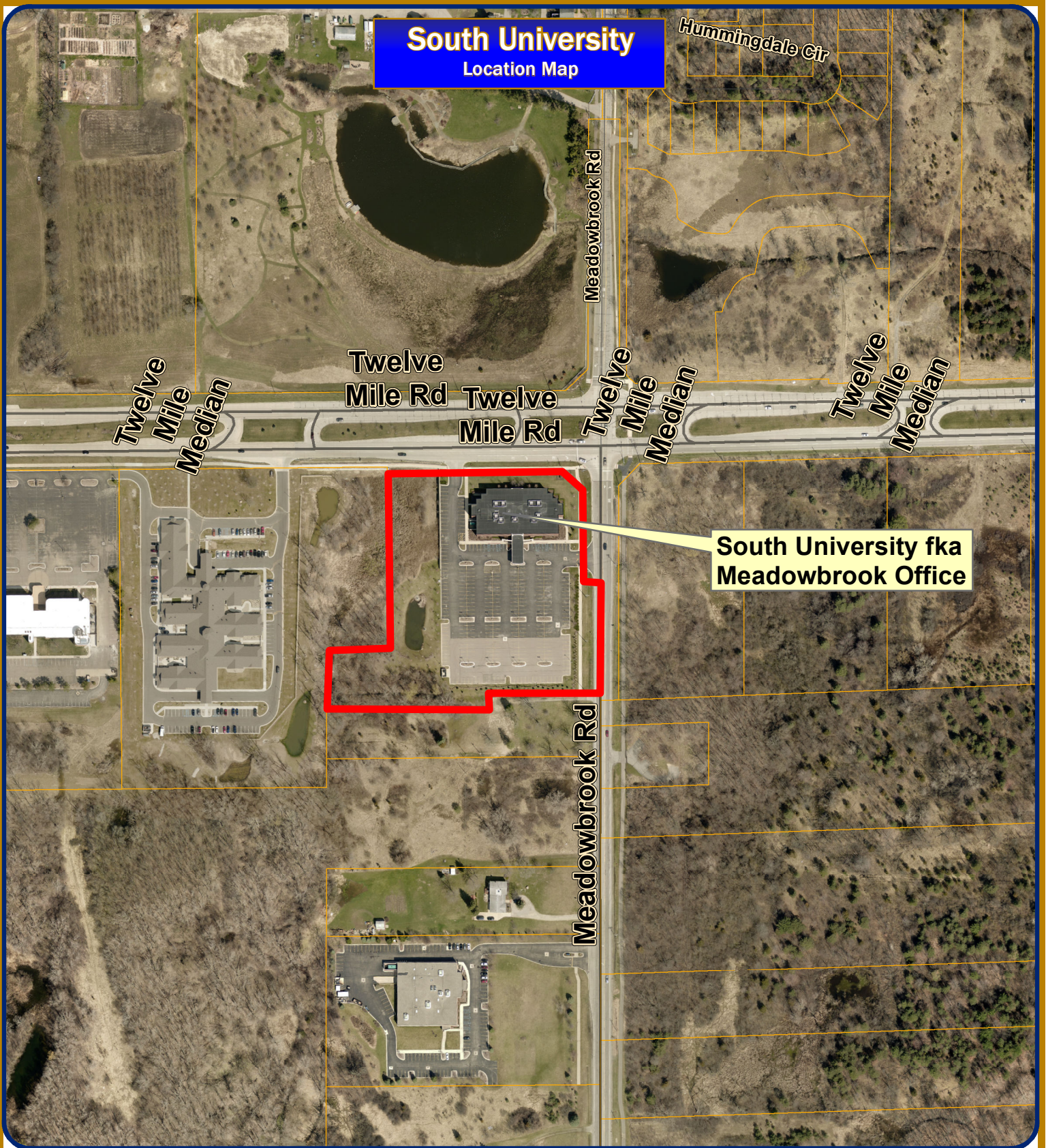

Map Author: Theresa Bridges
Date: March 13, 2018
Project:
Version #:

Amended By:
Date:
Department:

MAP INTERPRETATION NOTICE

Map information depicted is not intended to replace or substitute for any official or primary source. This map was intended to meet National Map Accuracy Standards and use the most recent, accurate sources available to the people of the City of Novi.
Boundary measurements and area calculations are approximate and should not be construed as survey measurements performed by a licensed Michigan Surveyor as defined in Michigan Public Act 132 of 1970 as amended. Please contact the City GIS Manager to confirm source and accuracy information related to this map.

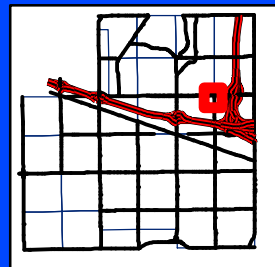

City of Novi

Engineering Division
Department of Public Services
26300 Lee BeGole Drive
Novi, MI 48375
cityofnovi.org

0 65 130 260 390
Feet

1 inch = 315 feet



November 11, 2009

CITY OF NOVI
CITY CLERK'S OFFICE

2009 NOV 13 P 2:42

30903 Northwestern Highway
P.O. Box 3040
Farmington Hills, MI 48333-3040
Tel: 248-851-9500
Fax: 248-851-2158
www.secrestwardle.com

Rob Hayes, Public Services Director
CITY OF NOVI
45175 West Ten Mile Road
Novi, Michigan 48375-3024

Elizabeth M. Kudla
Direct: 248-539-2846
bkudla@secrestwardle.com

**Re: Meadowbrook Office Building – SP01-04
Utilities Review for Acceptance
Our File No. 600051.NOVI**

Dear Mr. Hayes:

We have received and reviewed, and enclosed please find, the following documents for Meadowbrook Office Building in Section 14 of the City:

- ✓ 1. Sanitary Sewer System Easement *Recorded on 1/14/10 14-200-039*
- ✓ 2. Water System Easement
3. Bill of Sale
- 4. Sidewalk Easement
- ✓ 5. Emergency Access Easement *recorded on 2/04/10*
- 6. Warranty Deed (Meadowbrook Road Right of Way)
- 7. Partial Discharge of Mortgage (Meadowbrook Road Right of Way)
8. Commitment for Title Insurance
9. Maintenance and Guarantee Bond

We have the following comments relating to the above-named documents:

HEFCO Meadowbrook Office Building, LLC, seeks to convey water and sanitary sewer system facilities, as well as corresponding easements for operation, maintenance and repair of the water and sewer facilities serving the Meadowbrook Office Building in Section 14 of the City, to the City of Novi. Our office has reviewed and approves the format and language of the Water and Sanitary Sewer System Easements and corresponding Bills of Sale. The City's Consulting Engineer has reviewed and approved the legal descriptions of the Easements and Bill of Sale. As such, we recommend acceptance of the Easements and the corresponding Bills of Sale.

The Maintenance and Guarantee Bond for utilities is in the City's standard form and the amount has been approved by the City's Consulting Engineer.

A Warranty Deed and corresponding Partial Discharge of Mortgage have been provided for the Meadowbrook Road Right-of-Way. Both documents are in order and the legal description has been reviewed and approved by the City's Consulting Engineer.

Rob Hayes, Public Services Director

November 11, 2009

Page 2

An Emergency Access Easement has been provided over the site for use by emergency service providers. The terms and conditions of the Emergency Access Easement are acceptable. The legal description has been approved by the City's consulting engineer.

Finally, a Sidewalk Easement has been provided with respect to the Meadowbrook Road frontage of the site. The terms and conditions of the Sidewalk Easement are acceptable and the legal description had been approved by the City's Consulting Engineer.

The Water and Sanitary Sewer System Easements may be accepted by Affidavit of the City Engineer. The Warranty Deed and Sidewalk Easement should be placed on an upcoming City Council Agenda for acceptance. Because the Emergency Access Easement is for emergency service providers in general, it does not need to be specifically accepted by the City and may be recorded without any specific action by the City. Once accepted, the Water and Sanitary Sewer System Easements, the Emergency Access Easement, the Sidewalk Easement, the Warranty Deed and Partial Discharge of Mortgage should be recorded with the Oakland County Register of Deeds. The Bill of Sale, Maintenance and Guarantee Bond, and title report should remain in the City's file.

Please feel free to contact me with any questions or concerns in regard to this matter.

Very truly yours,

ELIZABETH M. KUDLA

EMK

Enclosures

- C: Maryanne Cornelius, Clerk (w/Original Enclosures)
 Marina Neumaier, Assistant Finance Director (w/Enclosures)
 Charles Boulard, Community Development Director (w/Enclosures)
 Barb McBeth, Deputy Community Development Director (w/Enclosures)
 Aaron Staup, Construction Engineering Coordinator (w/Enclosures)
 Taylor Reynolds and Tiffany Clark, Spalding DeDecker (w/Enclosures)
 Ted Meadows, Spalding DeDecker (w/Enclosures)
 Sarah Marchioni, Building Permit Coordinator (w/Enclosures)
 Sue Troutman, City Clerk's Office (w/Enclosures)
 Howard Friedlaender, HEFCO Properties (w/Enclosures)
 Thomas R. Schultz, Esquire (w/Enclosures)

SIDEWALK EASEMENT

NOW ALL MEN BY THESE PRESENTS, that HEFCO Meadowbrook Office Building, LLC, a Michigan limited liability company, whose address is 33533 W. 12 Mile Road, Suite 190, Farmington Hills, Michigan 48331, for and in consideration of One (\$1.00) Dollar, receipt and sufficiency of which is hereby acknowledged, hereby grants and conveys to the City of Novi, a Michigan Municipal Corporation, whose address is 45175 West Ten Mile Road, Novi, Michigan 48375, being exempt pursuant to MCLA 207.505(a) and MCLA 207.526(a), a permanent easement for a public walkway over across and through property located in Section 14, T.1N., R.8E., City of Novi, Oakland County, State of Michigan, more particularly described as follows:

{See attached and incorporated Exhibit A – Property Description Exhibit}

The permanent easement for the public walkway is more particularly described as follows:

{See attached and incorporated Exhibit B – Sidewalk Easement Area}

Grantee may enter upon sufficient land adjacent to said easement for the purpose of exercising the rights and privileges granted herein.

Grantee may install, repair, replace, improve, modify and maintain the easement area as shown in the attached and incorporated Exhibit B.

Grantor agrees not to build or to convey to others permission to build any structures or improvements on, over, across, in, through, or under the above-described easement.

This instrument shall run with the land first described above and shall be binding upon and inure to the benefit of the Grantor, Grantee, and their respective heirs, representatives, successors and assigns.

This easement shall allow public pedestrian and non-motorized traffic and shall permit maintenance, repair and replacement of the paving in the easement area.

Exempt pursuant to MCLA 207.505(a) and MCLA 207.526(a)

This instrument shall be binding and inure to the benefit of the parties hereto, their heirs, representatives, successors and assigns.

Dated this 12th day of October, 2009.

Signed by:

HEFCO Meadowbrook Office Building, LLC, a Michigan limited liability company

By: HEFCO Management, Inc., its Manager

By: 
Howard Friedlaender, its President

STATE OF MICHIGAN)
) SS
COUNTY OF OAKLAND)

The foregoing instrument was acknowledged before me this 12 day of October, 2009, by Howard Friedlaender, the President of HEFCO Management, Inc., on behalf of HEFCO Meadowbrook Office Building, LLC, a Michigan limited liability company.



Notary Public

County, Michigan

My Commission Expires: _____

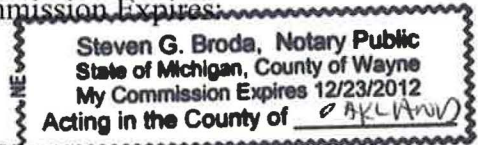

Drafted by:
Elizabeth M. Kudla
30903 Northwestern Hwy
Farmington Hills, MI 48334

When recorded return to:
Maryanne Cornelius, Clerk
City of Novi
45175 W. Ten Mile Rd
Novi, MI 48375

EXHIBIT A

PARCEL DESCRIPTION (BY OTHERS)

PART OF THE NORTHEAST QUARTER OF SECTION 14, T.1N., R.8E., NOVI TOWNSHIP, OAKLAND COUNTY, MICHIGAN BEING DESCRIBED AS:

COMMENCING AT THE NORTHEAST CORNER OF SAID SECTION 14; THENCE ALONG THE EAST LINE OF SAID SECTION 14 AND THE CENTERLINE OF MEADOWBROOK ROAD S.00°01'05"E., 372.40 FEET TO THE POINT OF BEGINNING OF THE PARCEL TO BE DESCRIBED; THENCE CONTINUING ALONG THE EAST LINE OF SAID SECTION 14 AND THE CENTERLINE OF MEADOWBROOK ROAD S.00°01'05"E., 155.60 FEET; THENCE S.89°24'35"W., 510.00 FEET; THENCE N.00°35'25"W., 417.98 FEET; THENCE ALONG THE SOUTH LINE OF 12 MILE ROAD N.89°24'35"E., 189.16 FEET; THENCE N.00°01'04"W, 8.00 FEET TO THE SOUTH LINE OF 12 MILE ROAD; THENCE ALONG THE SOUTH LINE OF 12 MILE ROAD N.89°24'35"E., 232.01 FEET; THENCE ALONG THE SOUTH LINE OF 12 MILE ROAD S.45°18'15"E., 70.36 FEET; THENCE ALONG THE WEST LINE OF MEADOWBROOK ROAD S.00°01'05"E., 220.40 FEET; THENCE N.89°24'35"E., 43.00 FEET TO THE POINT OF BEGINNING. CONTAINING 4.68 ACRES, MORE OR LESS.

SUBJECT TO THE RIGHTS OF THE PUBLIC OVER THE EXISTING 12 MILE ROAD AND MEADOWBROOK ROAD, AND TO ANY AND ALL EASEMENTS OR RESTRICTION OF RECORD.

PARCEL I.D. NO. 50-22-14-200-039

LEGAL DESCRIPTION OF SUBJECT PROPERTY - EXHIBIT A

HEFCO PROPERTIES

5138 VILLAGE COMMONS DRIVE
WEST BLOOMFIELD, MI 48322
PH: (248) 788-4500

**MEADOWBROOK
OFFICE BUILDING**

DATE
7-12-05

DRAWN BY
LAS

PROJECT No.
0432

SCALE
1" = 100'



29000 Inbeter Road, Suite 110
Southfield, MI 48034
(248) 357-7900
Fax (248) 357-3646

EXHIBIT B

12 MILE ROAD (DIVIDED ROAD)
VARIABLE WIDTH R.O.W

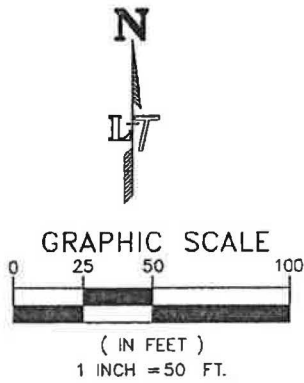
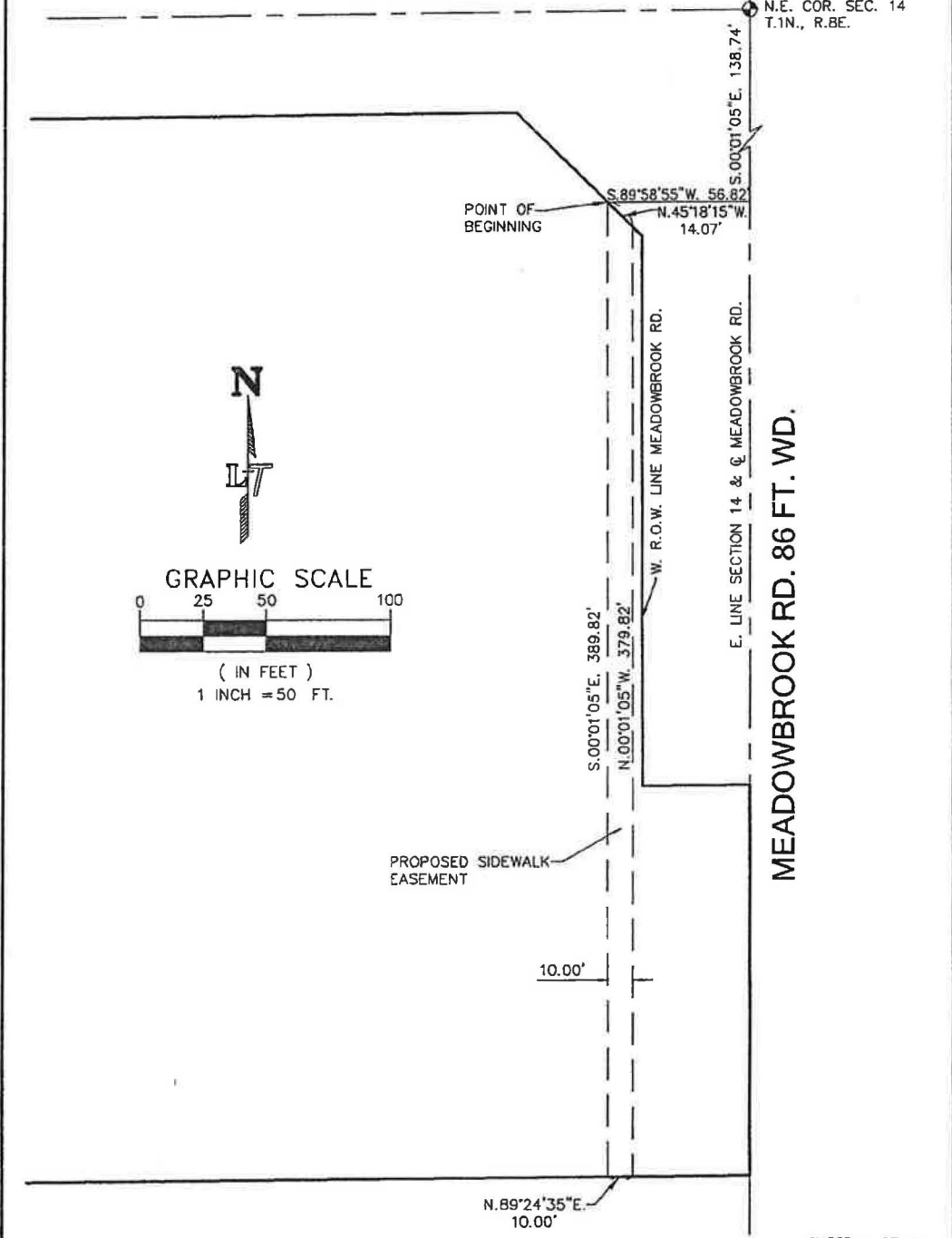

SHEET 1 OF 2

SIDEWALK EASEMENT SKETCH - EXHIBIT B

HEFCO PROPERTIES
5138 VILLAGE COMMONS DRIVE
WEST BLOOMFIELD, MI 48322
PH: (248) 788-4500

**MEADOWBROOK
OFFICE BUILDING**

DATE
7-12-05

DRAWN BY
LAS

PROJECT No.
0432

SCALE
1" = 50'



29000 Inkster Road, Suite 120
Southfield, MI 48034
(248) 357-7900
Fax (248) 357-3546

EXHIBIT B

A 10.00 FOOT WIDE STRIP OF LAND FOR THE INSTALLATION AND MAINTENANCE OF SIDEWALK, LOCATED IN THE N.E. 1/4 OF SECTION 14, T.1N., R.8E., NOVI TOWNSHIP, OAKLAND COUNTY, MICHIGAN, BEING DESCRIBED AS COMMENCING AT THE N.E. CORNER OF SAID SECTION 14; THENCE ALONG THE EAST LINE OF SAID SECTION AND THE CENTERLINE OF MEADOWBROOK ROAD (86.00 FEET WIDE) S.00°01'05"E. 138.74 FEET; THENCE S.89°58'55"W. 56.82 FEET TO THE POINT OF BEGINNING; THENCE S.00°01'05"E. 389.82 FEET; THENCE N.89°24'35"E. 10.00 FEET; THENCE N.00°01'00"W. 379.82 FEET TO THE WEST RIGHT-OF-WAY LINE OF SAID MEADOWBROOK ROAD; THENCE ALONG SAID RIGHT-OF-WAY LINE N.00°01'05"W. 220.40 FEET; THENCE N.45°18'15"W. 19.26 FEET TO THE POINT OF BEGINNING. CONTAINING 3,848 S.F. OF 0.09 ACRES OF LAND, MORE OR LESS.

SHEET 2 OF 2

SIDEWALK EASEMENT - EXHIBIT B
HEFCO PROPERTIES
 5138 VILLAGE COMMONS DRIVE
 WEST BLOOMFIELD, MI 48322
 PH: (248) 788-4500



29000 Inkster Road, Suite 110
 Southfield, MI 48034
 (248) 357-7900
 Fax (248) 357-3648

MEADOWBROOK
 OFFICE BUILDING

DATE
 7-12-05

PROJECT No.
 0432

DRAWN BY
 LAS

SCALE
 1" = 50'

WARRANTY DEED

KNOW ALL MEN BY THESE PRESENTS, that HEFCO Meadowbrook Office Building, LLC, a Michigan limited liability company, whose address is 33533 W. 12 Mile Road, Suite 190, Farmington Hills, Michigan 48331, being title holder to the following described parcel of land, bearing parcel identification number 50-22-14-200-039, to-wit:

[See attached Exhibit "A" attached hereto and made a part hereof]

Hereby conveys and warrants to the City of Novi, a Michigan Municipal Corporation, whose address is 45175 West Ten Mile Road, Novi, Michigan 48375, the following described Meadowbrook Road Right of Way premises situated in the City of Novi, County of Oakland, State of Michigan, to wit:

[See attached Exhibit "B" attached hereto and made a part hereof]

Together with all and singular the tenements, hereditaments and appurtenances thereunto belonging or in anywise appertaining, for the sum of One and no/100-----Dollars (\$1.00).

THE PROPERTY CONVEYED BY THIS DEED MAY BE LOCATED WITHIN THE VICINITY OF FARM LAND OR A FARM OPERATION. GENERALLY ACCEPTED AGRICULTURAL AND MANAGEMENT PRACTICES WHICH MAY GENERATE NOISE, DUST, ODORS, AND OTHER ASSOCIATED CONDITIONS MAY BE USED AND ARE PROTECTED BY THE MICHIGAN RIGHT TO FARM ACT.

Dated this 12th day of October, 2009.

Signed by

HEFCO Meadowbrook Office Building,
LLC, a Michigan limited liability company

By: HEFCO Management, Inc., its Manager

By: 
Howard Friedlaender, its President

STATE OF MICHIGAN)
) SS
COUNTY OF OKLAHOMA)

The foregoing instrument was acknowledged before me this 12 day of October, 2004, by Howard Friedlaender, the President of HEFCO Management, Inc., on behalf of HEFCO Meadowbrook Office Building, LLC, a Michigan limited liability company.

SG Broda
Notary Public

County, Michigan

My Commission Expires: _____
Steven G. Broda, Notary Public
State of Michigan, County of Wayne
My Commission Expires 12/23/2012
Acting in the County of OKLAHOMA

When Recorded Return to: Maryanne Cornelius, Clerk City of Novi 45175 West Ten Mile Road Novi, MI 48375-3024	Send Subsequent Tax Bills to: City of Novi 45175 West Ten Mile Road Novi, Michigan 48375	Drafted by: Elizabeth M. Kudla 30903 Northwestern Highway Farmington Hills, Michigan 48334
--	---	--

Part of Tax Parcel No. _____

Job No. _____ Recording Fee _____ Transfer Tax _____

EXHIBIT "A"

PARCEL DESCRIPTION AS PROVIDED:

Part of the Northeast 1/4 of Section 14, T1N-R8E, Novi Township, Oakland County, Michigan, being described as: Commencing at the Northeast Corner of said Section 14; thence along the East line of said Section 14 and the centerline of Meadowbrook Road, S 00°01'05" E, 372.40 feet, to the POINT OF BEGINNING of the Parcel to be described; thence continuing along the East line of said Section 14 and the centerline of Meadowbrook Road, S 00°01'05" E, 155.60 feet; thence S 89°24'35" W, 510.00 feet; thence N 00°35'25" W, 417.98 feet; thence along the South line of 12 Mile Road, N 89°24'35" E, 189.16 feet; thence N 00°01'04" W, 8.00 feet to the South line of 12 Mile Road; thence along the South line of 12 Mile Road, N 89°24'35" E, 232.01 feet; thence along the South line of 12 Mile Road, S 45°18'15" E, 70.36 feet; thence along the West line of Meadowbrook Road, S 00°01'05" E, 220.40 feet; thence N 89°24'35" E, 43.00 feet, to the POINT OF BEGINNING. Containing 4.68 acres, more or less.

Subject to the rights of the public over the existing 12 Mile Road and Meadowbrook Road, and to any and all easements or restriction of record.

Parcel I.D. No. 50-22-14-200-039

G:\08152\doc\08152-1_DESC-EX-A.doc
October 2, 2009

Job Number: 08152-1
Sheet: 1 OF 1

BOSS ENGINEERING
ENGINEERS & SURVEYORS

3121 E. Grand River Ave. Howell, MI 48843
Phone (517)546-4836 • Fax (517)548-1670



CHRISTOPHER S. FERGUS, P.S.

EXHIBIT "B"

RIGHT OF WAY DEDICATION

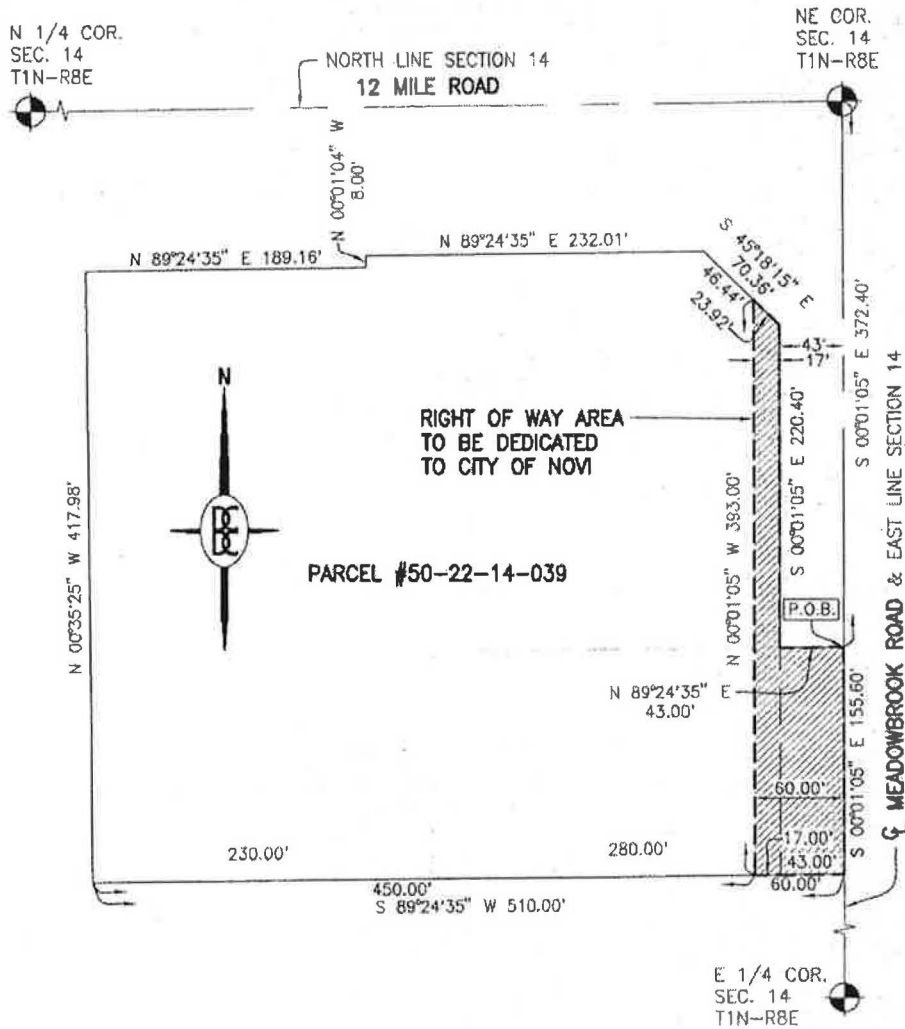

DESCRIPTION:
 PART OF THE NE 1/4,
 SEC. 14, T1N-R8E,
 NOVI TOWNSHIP,
 OAKLAND COUNTY,
 MICHIGAN

BOSS ENGINEERING
 ENGINEERS • SURVEYORS • PLANNERS
 LANDSCAPE ARCHITECTS
3121 E. GRAND RIVER AVE.
 HOWELL, MI 48841
 (800) 248-4726 FAX (313) 248-1470



CLIENT:
 HEFCO
 PROPERTIES



- LEGEND
- = IRON SET
 - = IRON FOUND
 - ⊙ = MONUMENT FOUND
 - * = FENCE
 - (R) = RECORDED
 - (M) = MEASURED

JOB NO. 08152-1	DATE 10-2-09	CREW	DR. AEB	CK. RFB
SHEET 1 OF 2	FB	CREW	DR. AEB	CK. RFB

G:\08152\dwg\08152-1.dwg, 10/2/2009 10:12:11 AM, andy

EXHIBIT "B"

DESCRIPTION OF RIGHT OF WAY AREA TO BE DEDICATED TO THE CITY OF NOVI:

Part of the Northeast 1/4 of Section 14, T1N-R8E, Novi Township, Oakland County, Michigan, more particularly described as follows: Commencing at the Northeast corner of Section 14; thence along the centerline of Meadowbrook Road and the East line of Section 14, S 00°01'05" E, 372.40 feet, to the POINT OF BEGINNING of the right-of-way to be described; thence continuing along the centerline of Meadowbrook Road and the East line of Section 14, S 00°01'05" E, 155.60 feet; thence S 89°24'35" W, 60.00 feet; thence N 00°01'05" W, 393.00 feet; thence S 45°18'15" E, 23.92 feet; thence S 00°01'05" E, 220.40 feet; thence N 89°24'35" E, 43.00 feet, to the POINT OF BEGINNING.

G:\08152\doc\08152-1_EA.doc
October 2, 2009

Job Number: 08152-1
Sheet: 2 OF 2

 **BOSS ENGINEERING**
ENGINEERS & SURVEYORS

3121 E. Grand River Ave. Howell, MI 48843
Phone (517)546-4836 • Fax (517)548-1670

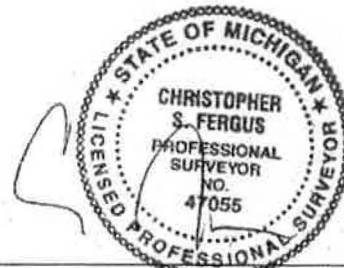

CHRISTOPHER S. FERGUS, P.S.

PARTIAL DISCHARGE OF MORTGAGE

INDEPENDENT BANK CORPORATION, a Michigan banking corporation (formerly known as Independent Bank East Michigan), whose address is 201 W. Big Beaver Road, Suite 125, Troy, Michigan 48084, hereby releases and discharges the mortgage made and executed by HEFCO Meadowbrook Site, LLC, a Michigan limited liability company, whose address is 33533 W. 12 Mile Road, Suite 190, Farmington Hills, Michigan 48331 and HEFCO Meadowbrook Office Building, LLC, a Michigan limited liability company, whose address is 33533 W. 12 Mile Road, Suite 190, Farmington Hills, Michigan 48331, as to a portion of the Property described below which has been conveyed to the City of Novi as public Road Right of Way. Such mortgage having been executed on November 10, 2006 and recorded on November 13, 2006, in Liber 38381, Page 39, Oakland County Records, which Property is located in the City of Novi, County of Oakland, State of Michigan, commonly known as: 41555 Twelve Mile Road, having a parcel identification number of 50-22-14-200-039, and legally described as:

[See attached and incorporated Exhibit A]

Such mortgage shall be discharged only as to the portion of the Property consisting of the Meadowbrook Road Right of Way, and legally described as:

[See attached and incorporated Exhibit B]

MORTGAGEE

INDEPENDENT BANK

By: SGM
(Print Name: Steven Gubrona)

Its: Vice President

ACKNOWLEDGMENT

STATE OF MICHIGAN)
)SS
COUNTY OF OAKLAND)

This Partial Discharge of Mortgage was acknowledged before me on this 12th day of October, 2009, by Steven G. Broda, the Vice President of Independent Bank on its behalf.

Mara J. Bloink

Notary Public

_____ County, Michigan

My Commission Expires: _____

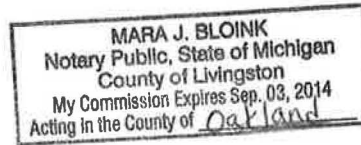

Drafted by:
Elizabeth M. Kudla, Esq.
30903 Northwestern Hwy., Ste. 3040
Farmington Hills, Michigan 48333-3040

When recorded return to:

Maryanne Cornelius
City Clerk
City of Novi
45175 W. Ten Mile Road
Novi, MI 48375

EXHIBIT "A"

PARCEL DESCRIPTION AS PROVIDED:

Part of the Northeast 1/4 of Section 14, T1N-R8E, Novi Township, Oakland County, Michigan, being described as: Commencing at the Northeast Corner of said Section 14; thence along the East line of said Section 14 and the centerline of Meadowbrook Road, S 00°01'05" E, 372.40 feet, to the POINT OF BEGINNING of the Parcel to be described; thence continuing along the East line of said Section 14 and the centerline of Meadowbrook Road, S 00°01'05" E, 155.60 feet; thence S 89°24'35" W, 510.00 feet; thence N 00°35'25" W, 417.98 feet; thence along the South line of 12 Mile Road, N 89°24'35" E, 189.16 feet; thence N 00°01'04" W, 8.00 feet to the South line of 12 Mile Road; thence along the South line of 12 Mile Road, N 89°24'35" E, 232.01 feet; thence along the South line of 12 Mile Road, S 45°18'15" E, 70.36 feet; thence along the West line of Meadowbrook Road, S 00°01'05" E, 220.40 feet; thence N 89°24'35" E, 43.00 feet, to the POINT OF BEGINNING. Containing 4.68 acres, more or less.

Subject to the rights of the public over the existing 12 Mile Road and Meadowbrook Road, and to any and all easements or restriction of record.

Parcel I.D. No. 50-22-14-200-039

G:\08152\doc\08152-1_DESC-EX-A.doc
October 2, 2009

Job Number: 08152-1
Sheet: 1 OF 1

 **BOSS ENGINEERING**
ENGINEERS & SURVEYORS

3121 E. Grand River Ave. Howell, MI 48843
Phone (517)546-4836 • Fax (517)548-1670



CHRISTOPHER S. FERGUS, P.S.

EXHIBIT "B"

RIGHT OF WAY DEDICATION

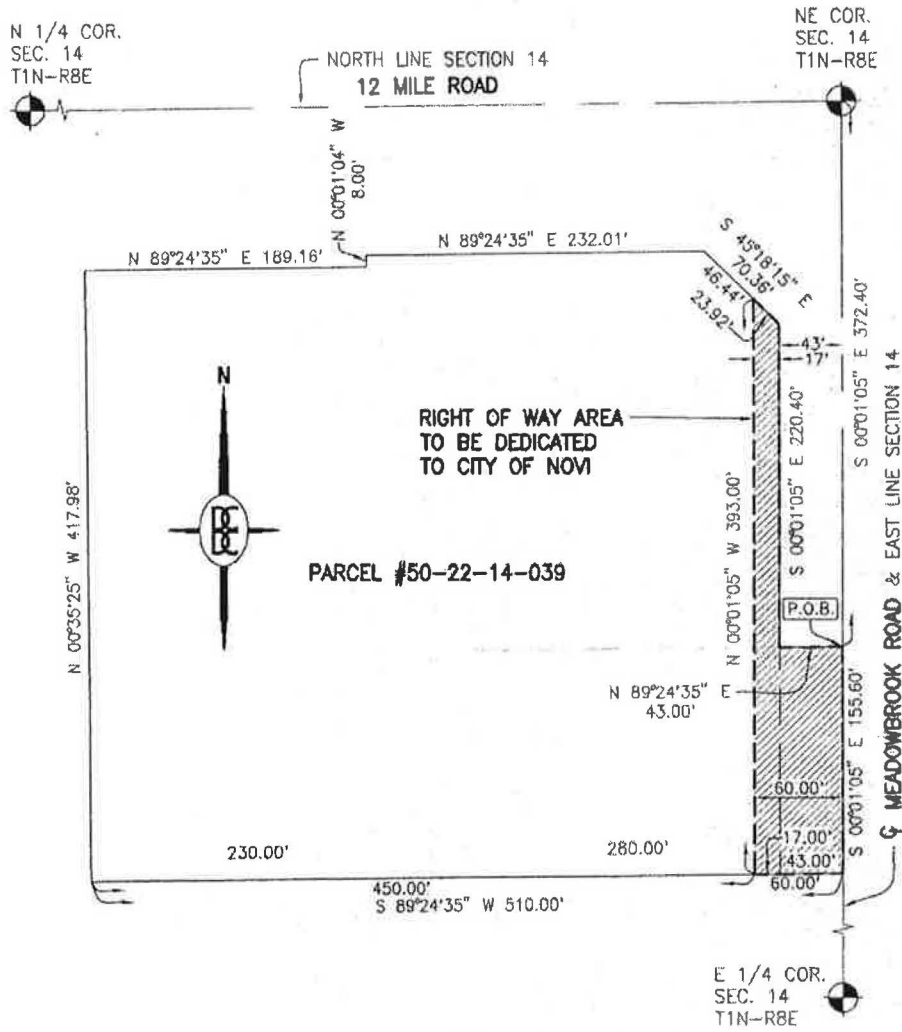

DESCRIPTION:
PART OF THE NE 1/4,
SEC. 14, T1N-R8E,
NOVI TOWNSHIP,
OAKLAND COUNTY,
MICHIGAN



CLIENT:
HEFCO
PROPERTIES

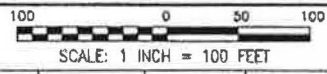

LEGEND
○ = IRON SET
● = IRON FOUND
⊙ = MONUMENT FOUND
* = FENCE
(R) = RECORDED
(M) = MEASURED

JOB NO.	08152-1	DATE	10-2-09		
SHEET	1 OF 2	FB	CREW	DR. AEB	CK. AEB

G:\08152\dwg\08152-1.dwg, 10/2/2009 10:12:11 AM, andy

EXHIBIT "B"

DESCRIPTION OF RIGHT OF WAY AREA TO BE DEDICATED TO THE CITY OF NOVI;

Part of the Northeast 1/4 of Section 14, T1N-R8E, Novi Township, Oakland County, Michigan, more particularly described as follows: Commencing at the Northeast corner of Section 14; thence along the centerline of Meadowbrook Road and the East line of Section 14, S 00°01'05" E, 372.40 feet, to the POINT OF BEGINNING of the right-of-way to be described; thence continuing along the centerline of Meadowbrook Road and the East line of Section 14, S 00°01'05" E, 155.60 feet; thence S 89°24'35" W, 60.00 feet; thence N 00°01'05" W, 393.00 feet; thence S 45°18'15" E, 23.92 feet; thence S 00°01'05" E, 220.40 feet; thence N 89°24'35" E, 43.00 feet, to the POINT OF BEGINNING.

G:\08152\doc\08152-1_EA.doc
October 2, 2009

Job Number: 08152-1
Sheet: 2 OF 2

 **BOSS ENGINEERING**
ENGINEERS & SURVEYORS

3121 E. Grand River Ave. Howell, MI 48843
Phone (517)546-4836 • Fax (517)548-1670

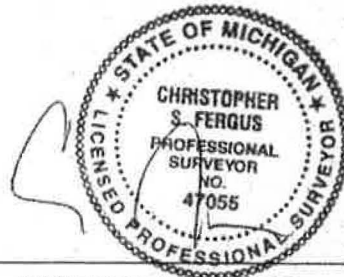

CHRISTOPHER S. FERGUS, P.S.