



CITY of NOVI CITY COUNCIL

**Agenda Item S
August 13, 2018**

SUBJECT: Approval of (1) a Resolution Concerning Acquisition of Property and Approving Declaration of Necessity and Taking and Authorization of Offer to Purchase, and (2) a Declaration of Taking, for the purpose of making a good faith offer in the amount of \$1,370, for a permanent sanitary sewer easement and a temporary grading permit over parcel 50-22-29-400-007 (48320 Nine Mile), for the construction of sanitary sewer as part of the project to extend sewer along Nine Mile Road from Kensington Road to Evergreen Court.

SUBMITTING DEPARTMENT: Department of Public Works, Water and Sewer Division

CITY MANAGER APPROVAL: 

EXPENDITURE REQUIRED	\$ 1,370
AMOUNT BUDGETED	\$ 4,151,581 (FY 2017-18 Budget Rollover)
APPROPRIATION REQUIRED	N/A
LINE ITEM NUMBER	592-592.00-976.029

BACKGROUND INFORMATION:

The Nine Mile Gravity Relief Sanitary Sewer Project involves the construction of sewer along Nine Mile from Kensington Road to Evergreen Court. Staff identified the project as high priority to eliminate the concern for redundancy of the Park Place pump station. Given the current proximity of the Park Place station, which is 1.6 miles from the closest gravity outlet (near Kensington Drive), a failure on the existing force main could result in sanitary service interruption and/or a major sewage overflow.

This project requires the acquisition of several easements prior to construction. During the design process, one permanent easement and one temporary easement were identified from 48320 Nine Mile (parcel 50-22-29-400-007). The enclosed letter was sent to the property owner requesting a donation of the permanent sanitary sewer easement and the temporary grading permit. The letter also informed the property owner they are entitled to just compensation for the fair market value of the requested easements.

To formalize the valuation in the form of an offer, staff has worked with the City Attorney to prepare a *Resolution Concerning Acquisition of Property and Approving Declaration of Necessity and Taking*, and a *Declaration of Taking* to allow the City to begin proceedings to acquire the easements through eminent domain since the City has been unable to acquire the easements for the amounts stated in the offer letter.

This project is expected to begin construction later this fall or winter.

RECOMMENDED ACTION: Approval of (1) a Resolution Concerning Acquisition of Property and Approving Declaration of Necessity and Taking and Authorization of Offer to Purchase, and (2) a Declaration of Taking, for the purpose of making a good faith offer in the

amount of \$1,370, for a permanent sanitary sewer easement and a temporary grading permit over parcel 50-22-29-400-007 (48320 Nine Mile), for the construction of sanitary sewer as part of the project to extend sewer along Nine Mile Road from Kensington Road to Evergreen Court.

NINE MILE GRAVITY SEWER PROJECT

Location Map

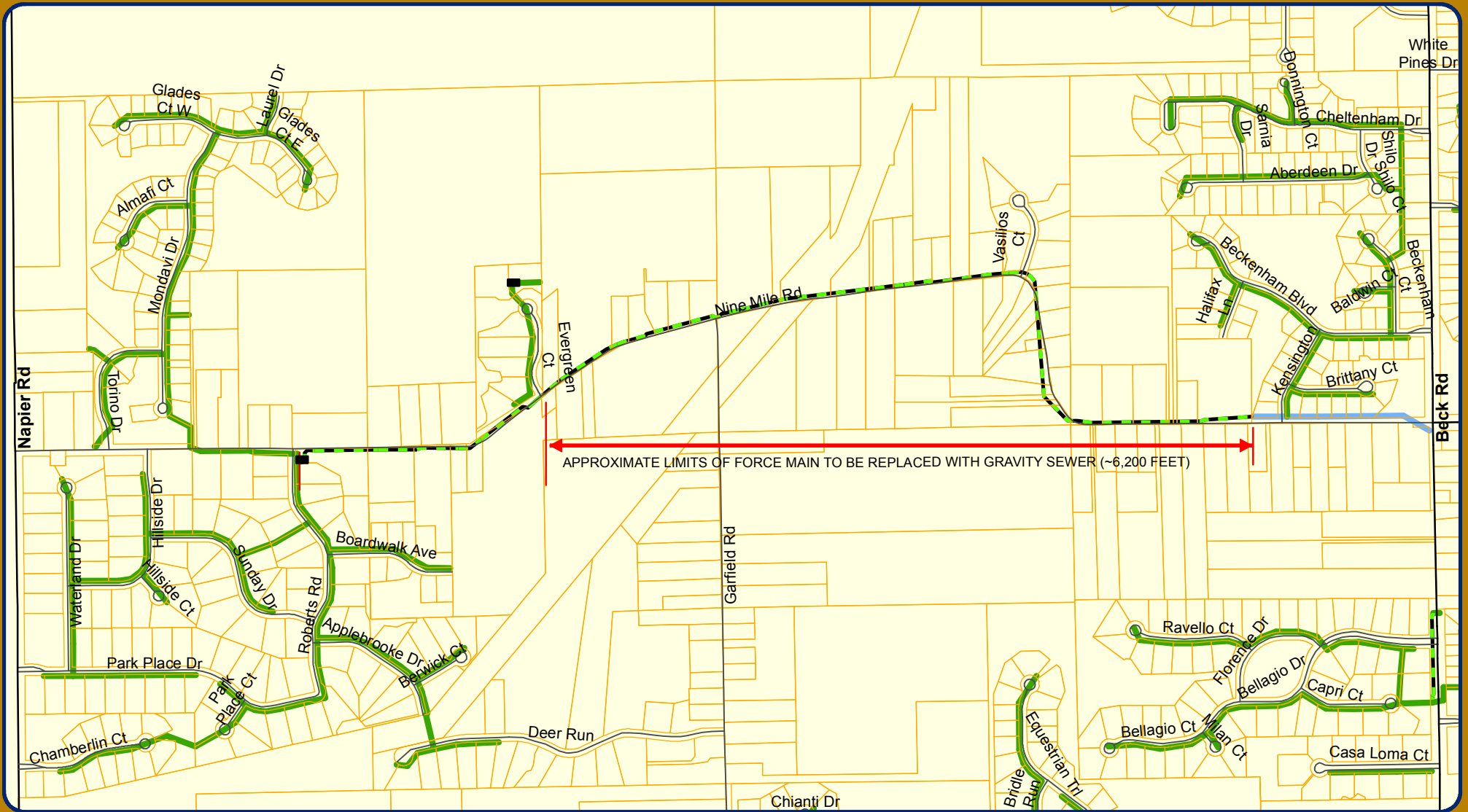



APPROXIMATE LIMITS OF FORCE MAIN TO BE REPLACED WITH GRAVITY SEWER (~6,200 FEET)

Map Author: Croy
 Date: 4/28/17
 Project: Nine Mile Gravity Sewer
 Version #: v1.0

MAP INTERPRETATION NOTICE

Map information depicted is not intended to replace or substitute for any official or primary source. This map was intended to meet National Map Accuracy Standards and use the most recent, accurate sources available to the people of the City of Novi. Boundary measurements and area calculations are approximate and should not be construed as survey measurements performed by a licensed Michigan Surveyor as defined in Michigan Public Act 132 of 1970 as amended. Please contact the City GIS Manager to confirm source and accuracy information related to this map.

Map Legend

-  6" Sanitary Force Main
-  8" Gravity Sanitary Sewer
-  12" Gravity Sanitary Sewer



City of Novi
 Engineering Division
 Department of Public Services
 26300 Lee BeGole Drive
 Novi, MI 48375
cityofnovi.org

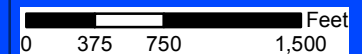

**RESOLUTION CONCERNING THE ACQUISITION
OF PROPERTY AND APPROVING DECLARATION OF NECESSITY AND TAKING**

City of Novi
County of Oakland, Michigan

Minutes of a _____ Meeting of the City Council of the City of Novi, County of Oakland, Michigan, held in the City Hall in said City on _____, 2018, at 7:00 o'clock P.M. Prevailing Eastern Time.

PRESENT: Councilmembers _____

ABSENT: Councilmembers _____

The following preamble and Resolution were offered by Councilmember _____ and supported by Councilmember _____.

WHEREAS, present conditions in the City of Novi, Oakland County, Michigan, necessitate the construction of a sanitary sewer extension along the frontage of Parcel No. 22-29-400-007 (the "Improvements"), in the City of Novi, Oakland County, State of Michigan, to-wit:

PARCEL DESCRIPTION (50-22-29-400-007)
(Per Oakland County Tax Rolls)

PARCEL

A PARCEL OF LAND SITUATED IN THE SE 1/4 OF SECTION 29, TOWN 1 NORTH, RANGE 8 EAST, CITY OF NOVI, OAKLAND COUNTY, MICHIGAN, DESCRIBED AS FOLLOWS: BEGINNING AT THE SOUTH 1/4 CORNER OF SAID SECTION 29; THENCE N 00°13'15.11 E 450.0 FEET; THENCE EAST 237.88 FEET; THENCE S 00°04'52.11 E 450.0 FEET; THENCE WEST 240.25 FEET TO THE POINT OF BEGINNING. SUBJECT TO ALL EASEMENTS AND RESTRICTIONS OF RECORD, IF ANY.

PERMANENT EASEMENT

A PARCEL OF LAND SITUATED IN THE SE 1/4 OF SECTION 29, TOWN 1 NORTH, RANGE 8 EAST, CITY OF NOVI, OAKLAND COUNTY, MICHIGAN, DESCRIBED AS FOLLOWS: COMMENCING AT THE SOUTH 1/4 CORNER OF SAID SECTION 29; THENCE EAST 240.25 FEET; THENCE N 00°04'52.11 W 33.0 FEET; THENCE WEST 111.49 FEET ALONG THE NORTH RIGHT OF WAY LINE OF WEST NINE MILE ROAD TO THE POINT OF

BEGINNING; THENCE CONTINUING WEST 35.0 FEET ALONG SAID NORTH LINE; THENCE NORTH 10.0 FEET; THENCE EAST 35.0 FEET; THENCE SOUTH 10.0 FEET TO THE POINT OF BEGINNING.

CONTAINS 350 SQUARE FEET OR 0.008 ACRES OF LAND, MORE OR LESS. SUBJECT TO ALL EASEMENTS AND RESTRICTIONS OF RECORD, IF ANY.

TEMPORARY EASEMENT

A PARCEL OF AND SITUATED IN THE SE 1/4 OF SECTION 29, TOWN 1 NORTH, RANGE 8 EAST, CITY OF NOVI, OAKLAND COUNTY, MICHIGAN, DESCRIBED AS FOLLOWS: COMMENCING AT THE S 1/4 CORNER OF SAID SECTION 29; THENCE N 00°13'15" E 98.48 FEET TO THE POINT OF BEGINNING; THENCE CONTINUING N 00°13'15" E 26.29 FEET; THENCE S 34°34'45" E 92.63 FEET; THENCE N 89°27'49" E 74.95 FEET; THENCE S 00°32'11" E 15.0 FEET; THENCE S 89°27'49" W 82.92 FEET; THENCE N 34°34'45" W 79.02 FEET TO THE POINT OF BEGINNING. CONTAINS 0.057 ACRES OF LAND.

WHEREAS, plans for the improvements are on file with the City Clerk's Office; and

WHEREAS, it has been determined that said improvements are necessary for the use and benefit of the public; and

WHEREAS, in order to construct said improvements, it is necessary that the City acquire a permanent Sanitary Sewer Easement and a Temporary Construction Easement to the above-described real estate.

WHEREAS, the City has caused a valuation of the subject property to be prepared;

WHEREAS, value of the easements over the subject property is One Thousand Three Hundred and Seventy (\$1,370.00) Dollars.

WHEREAS, the City has determined that it is in the best interests of the City to offer to purchase the easement over the subject property from the owner of such property, and to take such other actions as are deemed necessary to acquire the subject property for the purposes of constructing the improvements;

NOW, THEREFORE, BE IT RESOLVED, by the authority vested in the City of Novi by law, that it is hereby declared and determined that it is necessary to construct a sanitary sewer extension along the frontage of Parcel No. 22-29-400-007 (the "Improvements") under and

through the above-described property within the City of Novi in accordance with the plans prepared by the City, and that said improvements are necessary for the use and benefit of the public; and

BE IT FURTHER RESOLVED, that the Mayor of the City is hereby authorized to execute, on behalf of the City, a good faith Offer to Purchase, a copy of which is attached hereto as Exhibit A, calling for the payment of One Thousand Three Hundred and Seventy (\$1,370.00) Dollars for a permanent Sanitary Sewer Easement and Temporary Construction Easement over the subject property. The above amounts have been established as just compensation for the acquisition of the property, based upon a valuation of the property and the desire to complete the sale short of litigation.

BE IT FURTHER RESOLVED, that after the execution of the good faith Offer to Purchase by the Mayor, the good faith Offer to Purchase shall be submitted to the owners of the property;

BE IT FURTHER RESOLVED, that in the event the Sellers fail to accept the good faith Offer to Purchase within fourteen (14) days of the date of delivery, the City Manager is hereby authorized to execute the Declaration of Taking, which is attached hereto;

BE IT FURTHER RESOLVED, that in the event the offer is not accepted as set forth above, the Mayor, City Clerk, and City Attorney are authorized to take all actions required to obtain a permanent Sanitary Sewer Easement and Temporary Construction Easement in the subject property by eminent domain.

BE IT FURTHER RESOLVED, that in the event the offer is not accepted as set forth above, and the Declaration is executed, the City finance officer is authorized and directed to place an amount equal to the amount contained in the good faith offer that was made to the property owners (\$1,370.00) into a separate account and to hold such money on deposit as the

estimated amount of just compensation to be paid in connection with the eminent domain proceedings.

BE IT FURTHER RESOLVED, that all resolutions and part of resolutions insofar as they conflict with the provisions of this Resolution be and the same hereby are rescinded.

AYES: Councilmembers _____

NAYES: Councilmembers _____

RESOLUTION DECLARED ADOPTED.

CORTNEY HANSON, CITY CLERK

CERTIFICATION

I hereby certify that the foregoing is a true and complete copy of a Resolution adopted by the City Council of the City of Novi at _____ meeting held this _____ day of _____, 2018.

CORTNEY HANSON, CITY CLERK

DECLARATION OF TAKING

A Resolution of Necessity having been adopted by the City of Novi setting forth that present conditions necessitate the construction of a sanitary sewer extension along Nine Mile Road along the frontage of Parcel No. 22-29-400-007 (the "Improvements") in the City of Novi, Oakland County, Michigan, in the interest of the public health, safety, and welfare, and that it is necessary to acquire a Permanent Sanitary Sewer Easement and Temporary Construction Easement over the property within the City of Novi for said Improvements, and that a good faith written offer to purchase said property will be made.

NOW, THEREFORE, by virtue of the authority vested in the City of Novi, by Act 279 of the Public Acts of 1909, as amended, and/or Act 149 of the Public Acts of 1911, as amended, or other applicable statutes, and in accordance with the provisions of Act 87 of Public Acts of 1980, as amended, it is now declared and determined that the easement property hereinafter described shall be taken for the purpose of constructing a sanitary sewer, in accordance with prepared plans showing said Improvements which are on file with the City Clerk's Office.

A statement of the estate of interest in the property being taken; a description of the property to be acquired, sufficient for its identification; the name of each known owner of said property; the name of each known person, other than the owner, having an interest in said property; a statement of the sum of money estimated by the City of Novi as just compensation for the property being acquired; and a statement whether the City of Novi reserves or waives its

rights to bring federal or state cost recovery actions against the present owner of the property are as follows:

1. Statement of the Estate of Interest Being Taken and Description of the Property.

PARCEL DESCRIPTION (50-22-29-400-007)
(Per Oakland County Tax Rolls)

PARCEL

PARCEL DESCRIPTION (50-22-29-400-007) (BASED ON OAKLAND COUNTY TAX ROLLS)

A PARCEL OF LAND SITUATED IN THE SE 1/4 OF SECTION 29, TOWN 1 NORTH, RANGE 8 EAST, CITY OF NOVI, OAKLAND COUNTY, MICHIGAN, DESCRIBED AS FOLLOWS: BEGINNING AT THE SOUTH 1/4 CORNER OF SAID SECTION 29; THENCE N 00°13'15.11 E 450.0 FEET; THENCE EAST 237.88 FEET; THENCE S 00°04'52.11 E 450.0 FEET; THENCE WEST 240.25 FEET TO THE POINT OF BEGINNING. SUBJECT TO ALL EASEMENTS AND RESTRICTIONS OF RECORD, IF ANY.

PERMANENT EASEMENT

A PARCEL OF LAND SITUATED IN THE SE 1/4 OF SECTION 29, TOWN 1 NORTH, RANGE 8 EAST, CITY OF NOVI, OAKLAND COUNTY, MICHIGAN, DESCRIBED AS FOLLOWS: COMMENCING AT THE SOUTH 1/4 CORNER OF SAID SECTION 29; THENCE EAST 240.25 FEET; THENCE N 00°04'52.11 W 33.0 FEET; THENCE WEST 111.49 FEET ALONG THE NORTH RIGHT OF WAY LINE OF WEST NINE MILE ROAD TO THE POINT OF BEGINNING; THENCE CONTINUING WEST 35.0 FEET ALONG SAID NORTH LINE; THENCE NORTH 10.0 FEET; THENCE EAST 35.0 FEET; THENCE SOUTH 10.0 FEET TO THE POINT OF BEGINNING. CONTAINS 350 SQUARE FEET OR 0.008 ACRES OF LAND, MORE OR LESS. SUBJECT TO ALL EASEMENTS AND RESTRICTIONS OF RECORD, IF ANY.

TEMPORARY EASEMENT

A PARCEL OF AND SITUATED IN THE SE 1/4 OF SECTION 29, TOWN 1 NORTH, RANGE 8 EAST, CITY OF NOVI, OAKLAND COUNTY, MICHIGAN, DESCRIBED AS FOLLOWS: COMMENCING AT THE S 1/4 CORNER OF SAID SECTION 29; THENCE N 00°13'15" E 98.48 FEET TO THE POINT OF BEGINNING; THENCE CONTINUING N 00°13'15" E 26.29 FEET; THENCE S 34°34'45" E 92.63 FEET; THENCE N 89°27'49" E 74.95 FEET; THENCE S 00°32'11" E 15.0 FEET; THENCE S 89°27'49" W 82.92 FEET; THENCE N 34°34'45" W 79.02 FEET TO THE POINT OF BEGINNING. CONTAINS 0.057 ACRES OF LAND.

Subject to all easements and restrictions of record, if any.

2. Names of Property Owner: Kenneth Brock and Susan Brock, husband and wife
3. Names of each person, other than the Owners, having a potential interest in the property: Bank of America, Board of County Road Commissioners, County of Oakland

4. Value of Easements based on Valuation of the Property from assessing records:

Permanent Sanitary Sewer Easement: \$ 620.00
Temporary Construction Easement \$ 751.00

5. The City of Novi reserves its rights to bring Federal or State cost recovery actions against the present owner of the property.

CITY OF NOVI

BY: _____
Peter Auger
City Manager

Dated: _____, 2018
STATE OF MICHIGAN)
) ss.
COUNTY OF OAKLAND)

The foregoing Declaration of Taking was acknowledged before me this ____ day of _____, 2018, by Peter Auger, as the City Manager, on behalf of the City of Novi.

Notary Public
Acting in Oakland County, Michigan
My Commission Expires: _____

Prepared by and when recorded return to:
Elizabeth K. Saarela (P 60265)
27555 Executive Drive, Suite 250
Farmington Hills, MI 48331
Phone: (248) 489-4100
Tax Identification No: (50-22-29-400-007)

SANITARY SEWER SYSTEM EASEMENT

KNOW ALL MEN BY THESE PRESENTS, that Kenneth Brock and Susan Brock, husband and wife, whose address is 48320 Nine Mile Road, Novi, MI 48374, (hereinafter referred to as "Grantor"), being title holder to the following described parcel of land, to-wit:

[See attached and incorporated Exhibit A]

Tax Identification Number: 50-22-29-400-007

for and in consideration of One (\$1.00) Dollar, receipt and sufficiency of which is hereby acknowledged, does hereby grant and convey to the City of Novi, a Michigan municipal corporation, whose address is 45175 W. Ten Mile, Novi, Michigan 48375, (hereinafter referred to as "Grantee"), a nonexclusive perpetual easement for sanitary sewer, over, upon, across, in, through, and under the following described real property, to-wit:

[See attached and incorporated Exhibit B]

and to enter upon sufficient land adjacent to said sanitary sewer easement for the purpose of exercising the rights and privileges granted herein.

Grantee may install, repair, replace, improve, modify and maintain the sanitary sewer lines, and all necessary appurtenances thereto, within the easement herein granted.

Grantor agrees not to build or to convey to others permission to build any permanent structures on, over, across, in, through, or under the above-described easement, except that, subject to Grantee's approval as part of an approved site plan, the Grantor may construct and/or install surface improvements to the property, including paved driveways, parking and/or walkways; landscaping; utilities and/or similar improvements, which improvements do not interfere with use, operation, maintenance, repair and replacement of the sanitary sewer in the easement areas shown on the attached and incorporated Exhibit B.

This instrument shall run with the land first described above and shall be binding upon and inure to the benefit of the Grantor, Grantee, and their respective heirs, representatives, successors and assigns.

IN WITNESS WHEREOF, the undersigned Grantor has affixed their signature this _____ day of _____, 2017.

GRANTOR:

Kenneth Brock

Susan Brock

STATE OF MICHIGAN)

)SS

COUNTY OF OAKLAND)

On this _____ day of _____, 2018, before me, personally appeared the above named Kenneth Brock and Susan Brock, husband and wife, to me known to be the person described in and who executed the foregoing instrument and acknowledged that they executed the same as their free act and deed.

Notary Public

_____ County, MI

My commission expires _____

THIS INSTRUMENT DRAFTED BY:

Elizabeth K. Saarela, Esquire
JOHNSON ROSATI SCHULTZ & JOPPICH, P.C.
27555 Executive Drive, Suite 250
Farmington Hills, Michigan 48331

AND WHEN RECORDED RETURN TO:

Cortney Hanson, Clerk
45175 Ten Mile
Novi, Michigan 48375

CONSENT TO EASEMENT

As the holder of a mortgagee interest in and to the property referenced in the Sanitary Sewer System Easement, dated _____, 20____, attached hereto and incorporated as Exhibit A, whereby Kenneth Brock and Susan Brock, husband and wife, grants and conveys said easement to the City of Novi, the undersigned hereby evidences its consent to the grant, conveyance, existence and recordation of said easement, which easement is hereby acknowledged and agreed to be superior to the interest of the undersigned and shall bind the undersigned and the heirs, successors and assigns of the undersigned.

IN WITNESS WHEREOF the undersigned has caused its signature to be placed on the ____ day of _____, 20____.

Bank of America

By: _____

Its:

STATE OF MICHIGAN)

) ss.

COUNTY OF OAKLAND)

The foregoing Consent to Easement was acknowledged before me this _____ day of _____, 20____, by _____, the _____ of _____, a Michigan _____.

Notary Public

_____ County, MI

My commission expires: _____

SANITARY SEWER EASEMENT SKETCH

Exhibit "A"

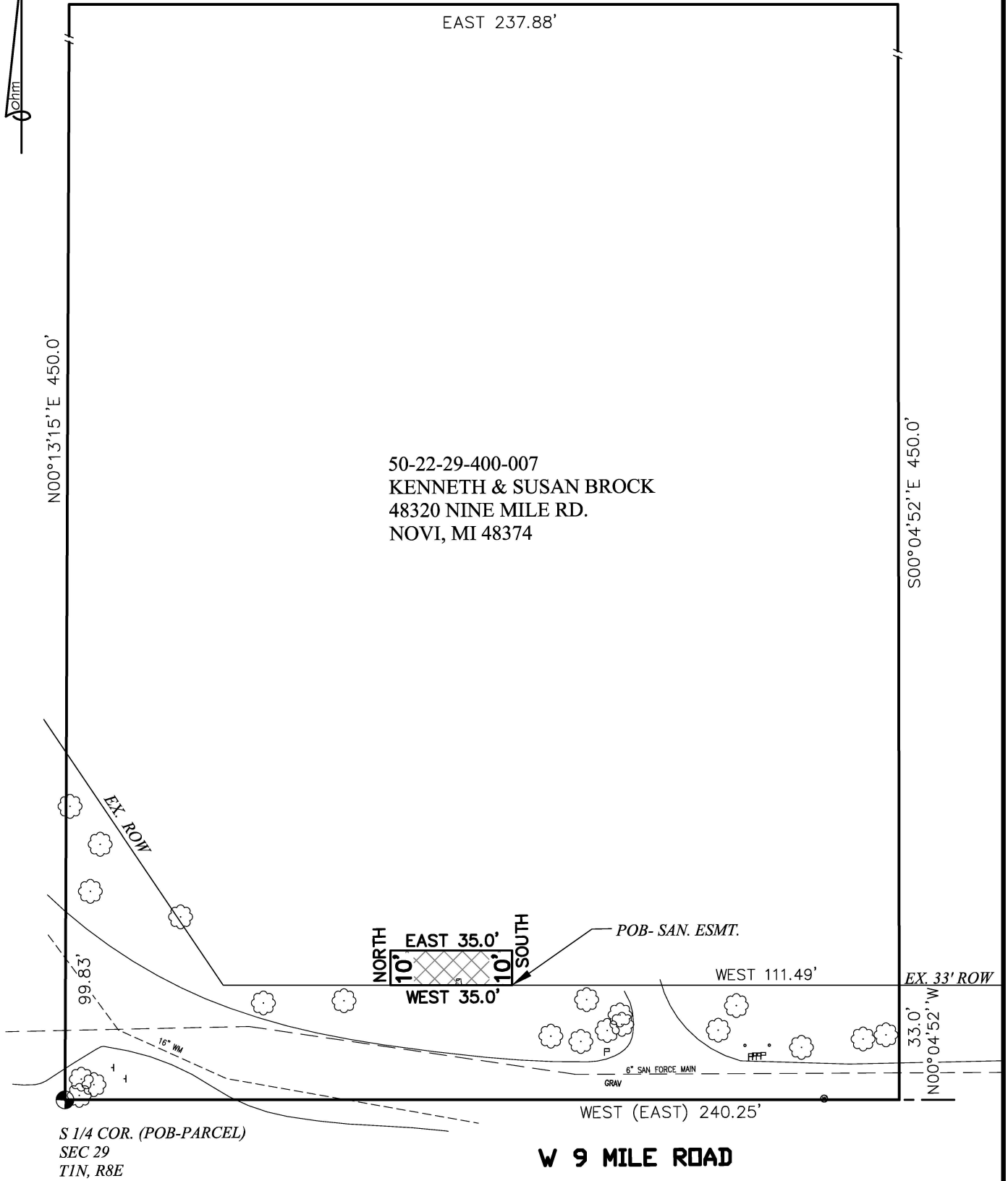

S 1/4 COR. (POB-PARCEL)
SEC 29
T1N, R8E

W 9 MILE ROAD

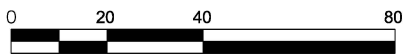

SCALE: 1" = 40'

LEGEND

- ROW RIGHT-OF-WAY
- PUBLIC LAND CORNER
- POB POINT OF BEGINNING
- SANITARY SEWER EASEMENT

SANITARY SEWER EASEMENT

PART OF THE SE 1/4 OF SECTION 29
T.1N., R.8E., CITY OF NOVI, OAKLAND COUNTY
TAX ID NO.: 50-22-29-400-007

CLIENT: CITY OF NOVI



34000 Plymouth Road | Livonia, MI 48150
p (734) 522-6711 | f (734) 522-6427

Advancing Communities

DATE: 05-02-18
DRAWN BY: SH
DWG: 48320NINE

SHEET
1 OF 2

JOB NO.
0163-16-0050

SANITARY SEWER EASEMENT DESCRIPTION

Exhibit "A"

PARCEL DESCRIPTION (50-22-29-400-007) (BASED ON OAKLAND COUNTY TAX ROLLS)

A parcel of land situated in the SE 1/4 of Section 29, Town 1 North, Range 8 East, City of Novi, Oakland County, Michigan, described as follows:

Beginning at the South 1/4 corner of said Section 29; thence N 00°13'15" E 450.0 feet; thence East 237.88 feet; thence S 00°04'52" E 450.0 feet; thence West 240.25 feet to the Point of Beginning. Subject to all easements and restrictions of record, if any.

SANITARY SEWER EASEMENT

A parcel of land situated in the SE 1/4 of Section 29, Town 1 North, Range 8 East, City of Novi, Oakland County, Michigan, described as follows:

Commencing at the South 1/4 corner of said Section 29; thence East 240.25 feet; thence N 00°04'52" W 33.0 feet; thence West 111.49 feet along the North right of way line of West Nine Mile Road to the Point of Beginning; thence continuing West 35.0 feet along said North line; thence North 10.0 feet; thence East 35.0 feet; thence South 10.0 feet to the Point of Beginning.

Contains 350 square feet or 0.008 acres of land, more or less. Subject to all easements and restrictions of record, if any.

SANITARY SEWER EASEMENT

PART OF THE SE 1/4 OF SECTION 29
T.1N., R.8E., CITY OF NOVI, OAKLAND COUNTY
TAX ID NO.: 50-22-29-400-007

CLIENT: CITY OF NOVI



34000 Plymouth Road | Livonia, MI 48150
p (734) 522-6711 | f (734) 522-6427

Advancing Communities

DATE: 05-02-18
DRAWN BY: SH
DWG: 48320NINE

SHEET
2 OF 2

JOB NO.
0163-16-0050

TEMPORARY GRADING PERMIT

I, _____, as the Owner of the property described as 48320 Nine Mile Road, Novi, MI 48374 (parcel 22-29-400-007) grant the City of Novi and its contractor (or subcontractors) permission to access, move men and equipment on and through, the right to store materials and excavated earth, remove vegetation and alter the underlying land in, over, upon and through the properties described above in the particular areas shown in Exhibit A, attached.

The work will include:

Construction activities related to the installation of a gravity sanitary sewer and sewer service leads along the Nine Mile Road corridor from Evergreen Court to a sewer connection point west of Kensington Road. The specific work may include grading, tree removals, modifications to driveway approaches, and related construction activities required for the proposed sanitary sewer work in accordance with the approved plans. All work is contained in the set of construction plans entitled “Nine Mile Road Sanitary Sewer” by OHM Advisors.

All portions of the Premises damaged or disturbed by Novi’s exercise of temporary easement rights shall be reasonably restored by Novi to the condition that existed prior to the damage or disturbance.

I understand this only grants permission to the Contractor to perform work directly relating to the listed project and upon completion of required grading operations the property will be fully restored.

By: Its:

Date

Contact Mailing Address

City, State, Zip

Phone Number

Email Address

STATE OF MICHIGAN)
) SS
COUNTY OF OAKLAND)

The foregoing instrument was acknowledged before me this _____ day of _____, 20___, by _____, the Owner of 48320 Nine Mile Road, Novi, MI 48374.

Notary Public
Oakland County, Michigan
My Commission Expires:

Drafted by:
Kyle Selter
OHM Advisors
34000 Plymouth Road
Livonia, MI 48150

EXHIBIT A

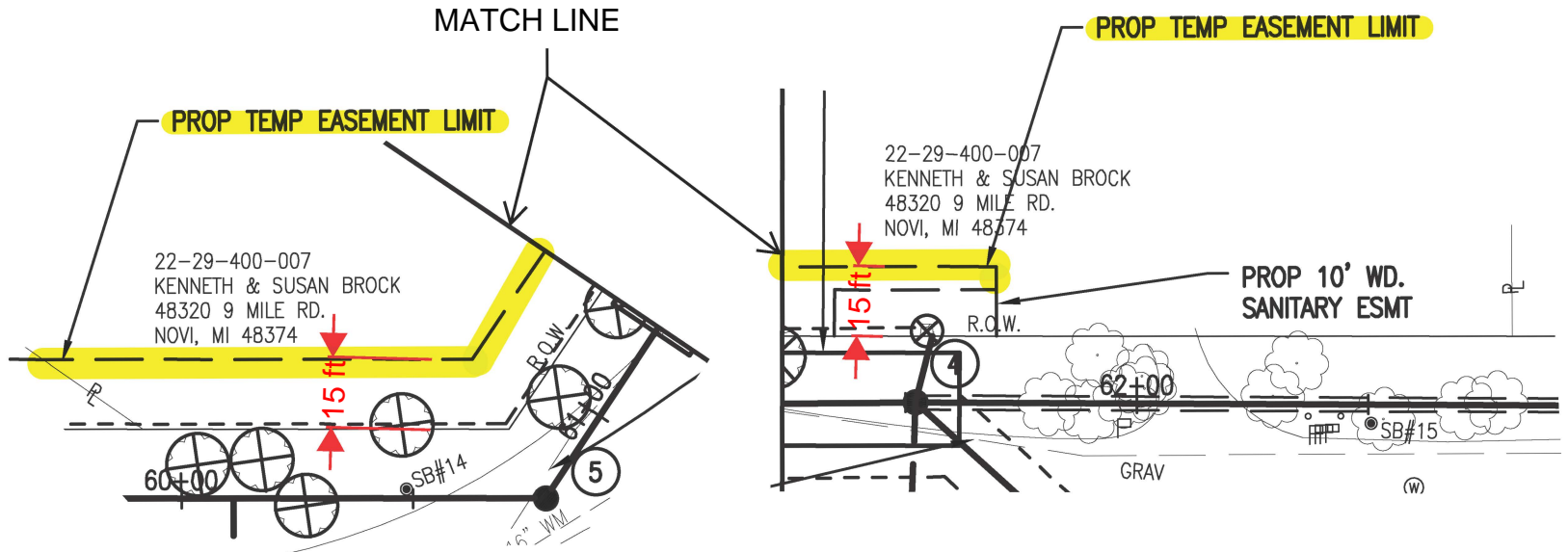



May 17, 2018

Kenneth and Susan Brock
48320 Nine Mile Road
Novi, MI 48374

CITY COUNCIL

Mayor
Bob Gatt

Mayor Pro Tem
Dave Staudt

Andrew Mutch

Wayne Wrobel

Laura Marie Casey

Gwen Markham

Kelly Breen

City Manager
Peter E. Auger

Engineering Senior Manager
George D. Melistas

Field Operations Senior Manager
Matt Wiktorowski

Fleet Asset Manager
Michael Rhatigan

Water & Sewer Senior Manager
Ben Croy, P.E.

RE: Nine Mile Sanitary Sewer Project

Dear Mr. and Mrs. Brock:

As you are aware, the City is planning to construct a sanitary sewer main along Nine Mile between Kensington Road and Evergreen Court. To facilitate construction of the project, easements will be required along a portion of the project limits, including a permanent and temporary easement along the Nine Mile frontage of your property. For your reference, the proposed easements have been enclosed for your review.

To help limit the cost of the project, and since this project provides a benefit to the property owners on Nine Mile, we are asking that these easements be donated. However, for your information, we determined the fair market value of the easements, which was determined based on the value of the property per square foot on the basis of assessment records. Per federal guidelines, the valuation of temporary easements are set at 10% of that value, and permanent easements are set at 50% of that value. The valuation for the easements being requested over your property is valued at \$1,370. This is not a good faith offer at this point, but rather just a valuation for informational purposes.

If you are satisfied with the enclosed easement documents, and choose to donate the easements, please return one signed, notarized copy of each document for approval by our City Council and subsequent recording with the Register of Deeds. **If you choose not to donate the easements for the project, please contact me by May 31st at 248-735-5635 to discuss purchase of the easements.** Please feel free to contact me to further discuss the project or easements, and to address any questions or concerns you may have.

Sincerely,

Ben Croy
Water and Sewer Senior Manager

Enclosures

Department of Public Services
Field Services Complex
26300 Lee BeGole Dr.
Novi, Michigan 48375
248.735.5640
248.735.5659 fax
cityofnovi.org