

# MEMORANDUM



**TO:** MEMBERS OF THE PLANNING COMMISSION  
**FROM:** CHRISTIAN CARROLL, PLANNER  
**SUBJECT:** TUSCANY RESERVE LOT 23 WOODLAND PERMIT  
**DATE:** JULY 8, 2021

---

The applicant, Cambridge Homes, seeks approval of a Woodland Use Permit, PBR21-0229, to remove twenty-six regulated woodland trees ranging in size from 8 to 34 inches diameter-at-breast-height (DBH) from a lot located at 48810 Castello Court, also known as Lot 23, Tuscany Reserve Subdivision. The subdivision is located north of Eight Mile Road and east of Garfield Road in Section 32 of the City. The Planning Commission reviewed the plans for Tuscany Reserve Subdivision in 2003 and approved a Woodland Use Permit for the majority of the lots. However, at the time, a number of lots on the north side of the intersection of Castello Court and Veneto Drive were not included in the Woodland Use Permit and have been handled on an individual basis. The applicant is requesting the removal of twenty-six regulated woodland trees in order to build a single-family structure on the lot. Lot 23 of Tuscany Reserve is the last vacant lot in the development.

The City's Environmental Consultant reviewed the request and prepared a review letter dated July 7, 2021, with the sections of the letter related to Lot 23 being the focus of the Planning Commission's consideration. Based on the plans provided, the property contains trees that are considered regulated by the City of Novi as they are greater than or equal to 8-inches DBH and located within an area mapped as Regulated Woodland. 57 Woodland Replacement Credits would be required, with 47 replacement credits required for the removals plus 10 replacement credits per the approved site plan and Woodland Use Permit for the Tuscany Reserve II Subdivision. The applicant intends on using the remaining extra 40.5 woodland replacement credits for Tuscany Reserve II Subdivision to help meet the required replacements. With the use of these 40.5 extra replacement credits, the applicant is still required to provide 16.5 Woodland Replacement Credits. The Environmental Consultant's review letter, which is attached, provides a detailed count and explanation of the required replacements. The applicant intends to plant as replacements on-site to the extent possible.

The proposed removals have no impact on the previously approved Woodland Use Permit, WD08-0001, nor does it have any impact on the previously approved and recorded Residential Unit Development (RUD) Agreement, other than the regulated woodland trees that are currently being proposed for removal from Lot 23. It should also be noted that the proposed removals are not located within any recorded conservation or preservation easements that abut and encroach onto the property. The Wetland Preservation Easement located on this property shall be maintained in its natural state. Please refer to the Environmental Consultant's review letter for additional information.

Per the City of Novi's Woodland Ordinance, where a proposed activity (i.e., home construction) does not otherwise require site plan or plat approval, the granting or denying of the (woodland) use permit shall be the responsibility of the Planning Commission. The applicant shall obtain approval of the Plan from Planning Commission prior to issuance of any permits. The Planning

Commission is asked to hold the public hearing and either approve or deny the requested woodland removal permit.

Section 37-26 of the Woodland Protection Ordinance states the following:

(b) Where a final subdivision plat or a final site development plan which includes activities regulated by this chapter has been reviewed and approved by the city in conformance with the requirements of this chapter, such approval together with any additional terms and conditions attached thereto shall be considered to have completed the requirements for a permit under this chapter which shall then be issued by the city.

(c) Unless the requirements of this chapter can be satisfied by the setting aside without encroachment of sufficient woodland areas, the developer of a single-family residential subdivision plat or single-family residential site condominium shall, as a part of use permit approval under this article, designate building areas for all structures and impervious surfaces on each subdivision lot or site condominium unit. Once such building areas have been approved and made a part of the use permit, no additional woodland use permit shall be required for the erection of structures within such a building area. **Activities on a subdivision lot or site condominium unit that extend beyond the confines of such a designated building or impervious area shall require an additional approval pursuant to this chapter, which shall only be approved when it is not otherwise feasible to utilize the lot or site condominium unit for single-family residential purposes.**

**SUGGESTED MOTION:**

**To approve Woodland Use Permit, PBR21-0229, for the removal of twenty-six regulated woodland trees within an area mapped as City Regulated Woodland on Lot 23 of the Tuscany Reserve Subdivision for the construction of a single-family residence. The approval is subject to on-site tree replacements to the extent possible and payment into the City's Tree Fund for any outstanding Woodland Replacement Credits, along with any other conditions as listed in the Environmental Consultant's review letter.**

MAPS  
Location  
Zoning  
Future Land Use  
Natural Features

# PBR21-0229 LOT 23 TUSCANY RESERVE

## LOCATION

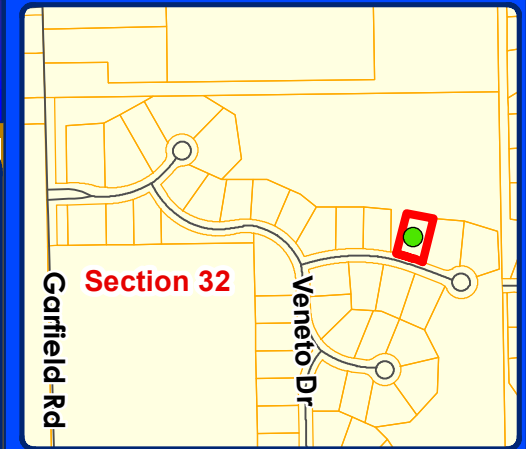

### LEGEND

 Subject Property



## City of Novi

Dept. of Community Development  
City Hall / Civic Center  
45175 W Ten Mile Rd  
Novi, MI 48375  
[cityofnovi.org](http://cityofnovi.org)

Map Author: Christian Carroll  
Date: 7/8/21  
Project: LOT 23 TUSCANY RESERVE  
Version #: 1



### MAP INTERPRETATION NOTICE

Map information depicted is not intended to replace or substitute for any official or primary source. This map was intended to meet National Map Accuracy Standards and use the most recent, accurate sources available to the people of the City of Novi. Boundary measurements and area calculations are approximate and should not be construed as survey measurements performed by a licensed Michigan Surveyor as defined in Michigan Public Act 132 of 1970 as amended. Please contact the City GIS Manager to confirm source and accuracy information related to this map.

# PBR21-0229 LOT 23 TUSCANY RESERVE ZONING

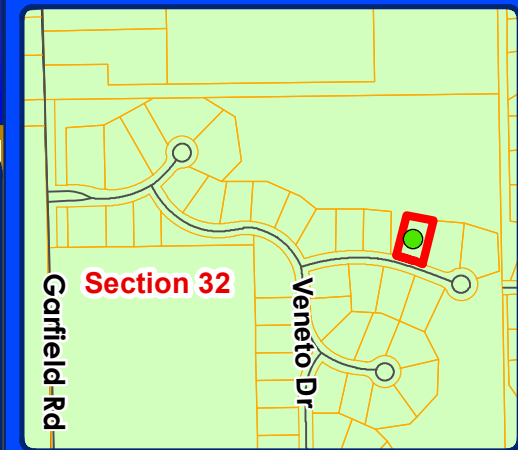
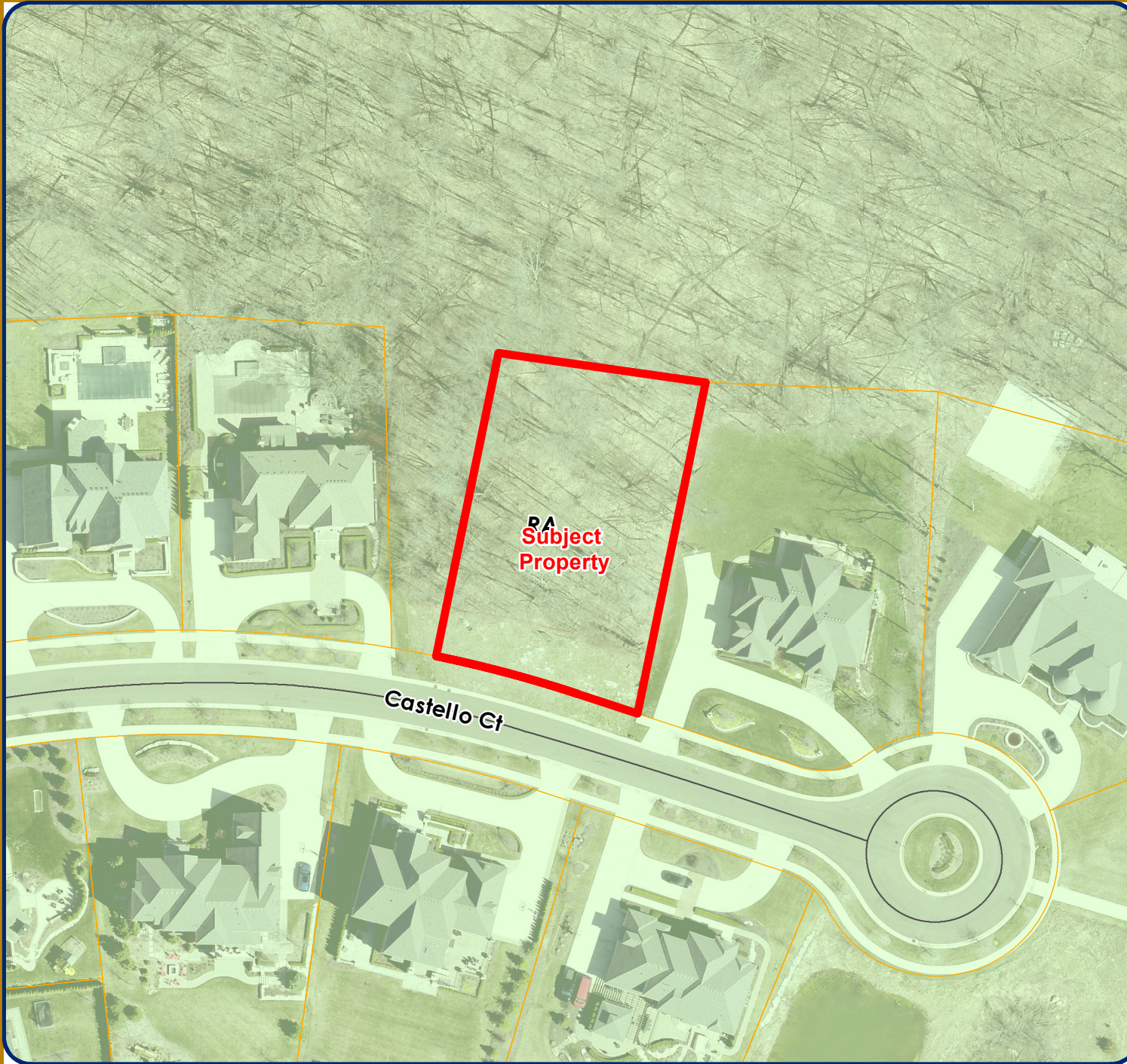

**LEGEND**

-  R-A: Residential Acreage
-  Subject Property



**City of Novi**  
Dept. of Community Development  
City Hall / Civic Center  
45175 W Ten Mile Rd  
Novi, MI 48375  
[cityofnovi.org](http://cityofnovi.org)

Map Author: Christian Carroll  
Date: 7/8/21  
Project: LOT 23 TUSCANY RESERVE  
Version #: 1

0 15 30 60 90 Feet  
1 inch = 83 feet



**MAP INTERPRETATION NOTICE**  
Map information depicted is not intended to replace or substitute for any official or primary source. This map was intended to meet National Map Accuracy Standards and use the most recent, accurate sources available to the people of the City of Novi. Boundary measurements and area calculations are approximate and should not be construed as survey measurements performed by a licensed Michigan Surveyor as defined in Michigan Public Act 132 of 1970 as amended. Please contact the City GIS Manager to confirm source and accuracy information related to this map.

# PBR21-0229 LOT 23 TUSCANY RESERVE

## FUTURE LAND USE

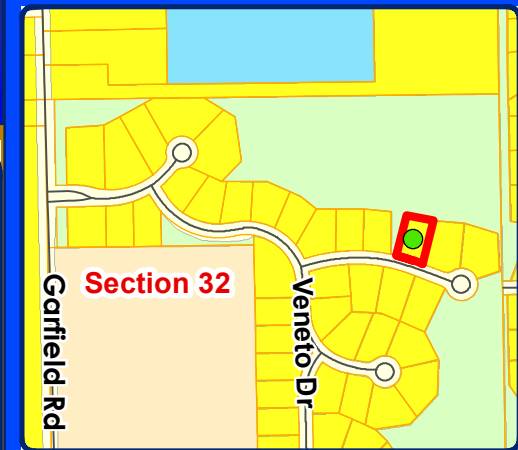

### LEGEND

- Single Family
- Educational Facility
- Public
- Private Park
- Subject Property



**City of Novi**  
Dept. of Community Development  
City Hall / Civic Center  
45175 W Ten Mile Rd  
Novi, MI 48375  
cityofnovi.org

Map Author: Christian Carroll  
Date: 7/8/21  
Project: LOT 23 TUSCANY RESERVE  
Version #: 1



### MAP INTERPRETATION NOTICE

Map information depicted is not intended to replace or substitute for any official or primary source. This map was intended to meet National Map Accuracy Standards and use the most recent, accurate sources available to the people of the City of Novi. Boundary measurements and area calculations are approximate and should not be construed as survey measurements performed by a licensed Michigan Surveyor as defined in Michigan Public Act 132 of 1970 as amended. Please contact the City GIS Manager to confirm source and accuracy information related to this map.

# PBR21-0229 LOT 23 TUSCANY RESERVE

## NATURAL FEATURES

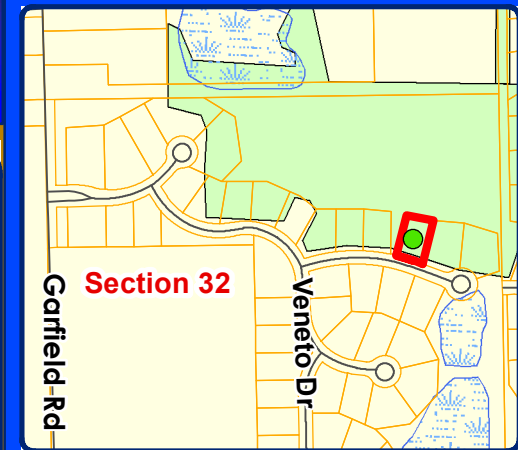

**LEGEND**

- WETLANDS
- WOODLANDS
- Subject Property



**City of Novi**  
Dept. of Community Development  
City Hall / Civic Center  
45175 W Ten Mile Rd  
Novi, MI 48375  
[cityofnovi.org](http://cityofnovi.org)

Map Author: Christian Carroll  
Date: 7/8/21  
Project: LOT 23 TUSCANY RESERVE  
Version #: 1

0 15 30 60 90 Feet  
1 inch = 83 feet



**MAP INTERPRETATION NOTICE**  
Map information depicted is not intended to replace or substitute for any official or primary source. This map was intended to meet National Map Accuracy Standards and use the most recent, accurate sources available to the people of the City of Novi. Boundary measurements and area calculations are approximate and should not be construed as survey measurements performed by a licensed Michigan Surveyor as defined in Michigan Public Act 132 of 1970 as amended. Please contact the City GIS Manager to confirm source and accuracy information related to this map.

**PLOT PLAN**



**LEGAL DESCRIPTION**

UNIT 23 OF, "TUSCANY RESERVE", A PART OF THE SOUTHWEST 1/4 OF SECTION 32, T.1N., R.8E., CITY OF NOVI, OAKLAND COUNTY, MICHIGAN. SUBJECT TO EASEMENTS AND RESTRICTIONS OF RECORD.

**RECEIVED**

JUN 28 2021

CITY OF NOVI  
COMMUNITY DEVELOPMENT

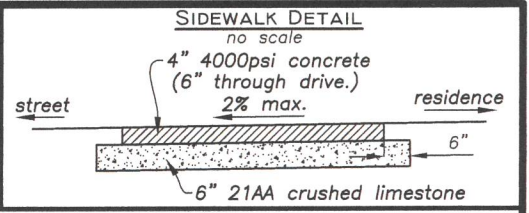

Note: Sidewalks must be constructed according to ADA Standards



Know what's below.  
Call before you dig.

**Tree replacement calculation**

| Tree Size  | Number of Trees Removed | Ratio Replacement /Removed Tree | Total Replacements Required |
|------------|-------------------------|---------------------------------|-----------------------------|
| 8-11"      | 12                      | 1                               | 12                          |
| 12-20"     | 10                      | 2                               | 20                          |
| 21-29"     | 2                       | 3                               | 6                           |
| 30"+       | 1                       | 4                               | 4                           |
| Multi-Stem | 1                       | Add Stems/8                     | 5                           |

Tree replacements required per approved Tuscany Reserve II Site Plan and Woodland use permit

Total Replacements Credits

Note: Trees to be replaced as per the homeowner's Landscape Plan.

- Legend**
- 000.00 = Existing Elevation
  - 000.00 (boxed) = Proposed Elevation
  - = Drainage Course
  - ~ = Silt Fence
  - F.G. = Brick Ledge
  - = Existing Contour
  - (TBR) = To be Removed
  - = Woodland Protection Fence

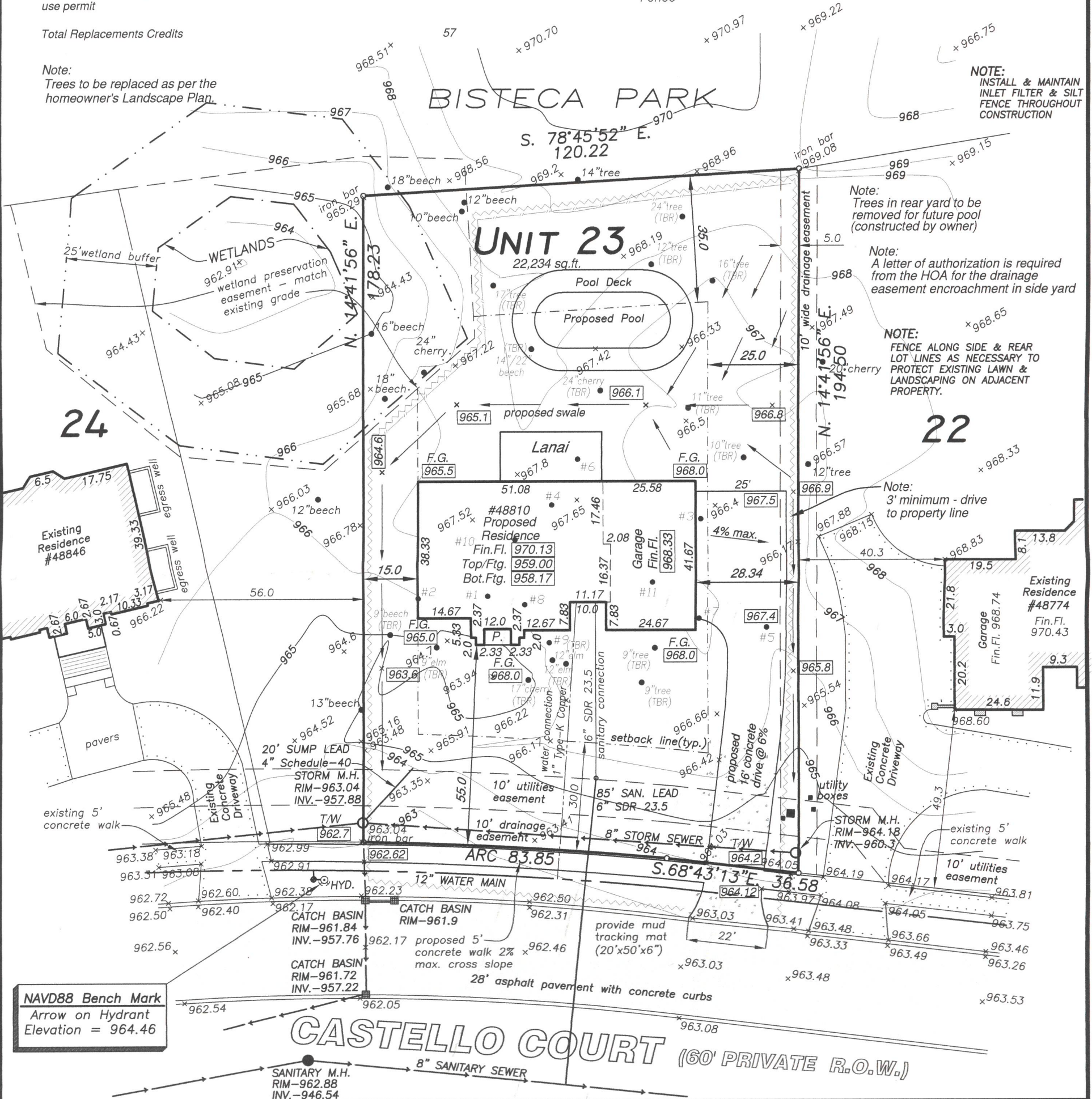

NAVD88 Bench Mark  
Arrow on Hydrant  
Elevation = 964.46



Note: A "Right-of-Way Permit" is required from the City of Novi Engineering Department must be issued prior to issuance of Building Permit.

Revised per city 24 June 2021



**GRADING PLAN**

prepared for: Cambridge Homes, Inc.  
47765 Bellagio Drive  
Northville, MI 48167  
(248) 348-3800

**JEKABSON & ASSOCIATES, P.C.**  
Professional Land Surveyors  
1320 Goldsmith, Plymouth, MI 48170  
(734) 414-7200 (734) 414-7272 fax

by *[Signature]*



|         |             |
|---------|-------------|
| PLAN    | Custom      |
| DATE    | 21 April 21 |
| JOB NO. | 16-05-020   |
| SCALE   | 1" = 30'    |
| DRAWN   | AAH         |
| CHECKED | JGE         |
| SHEET   | 1 OF 2      |

PBR21-0229

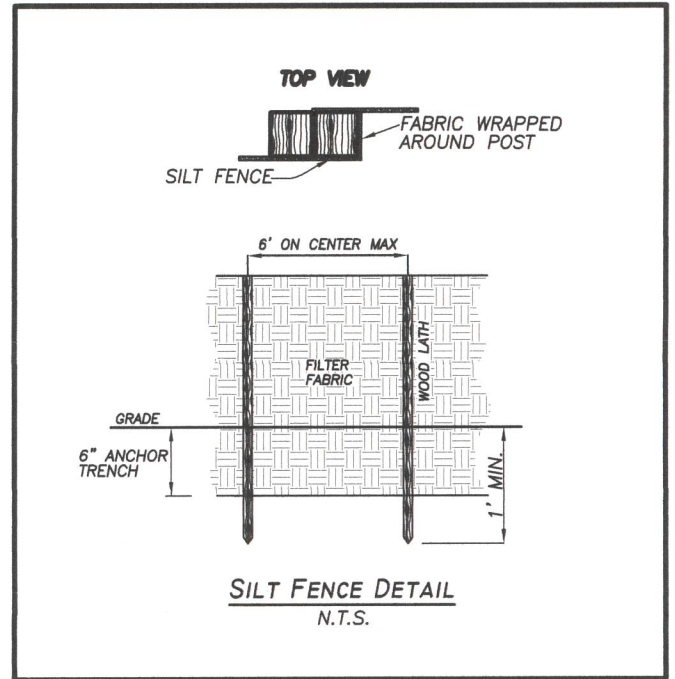
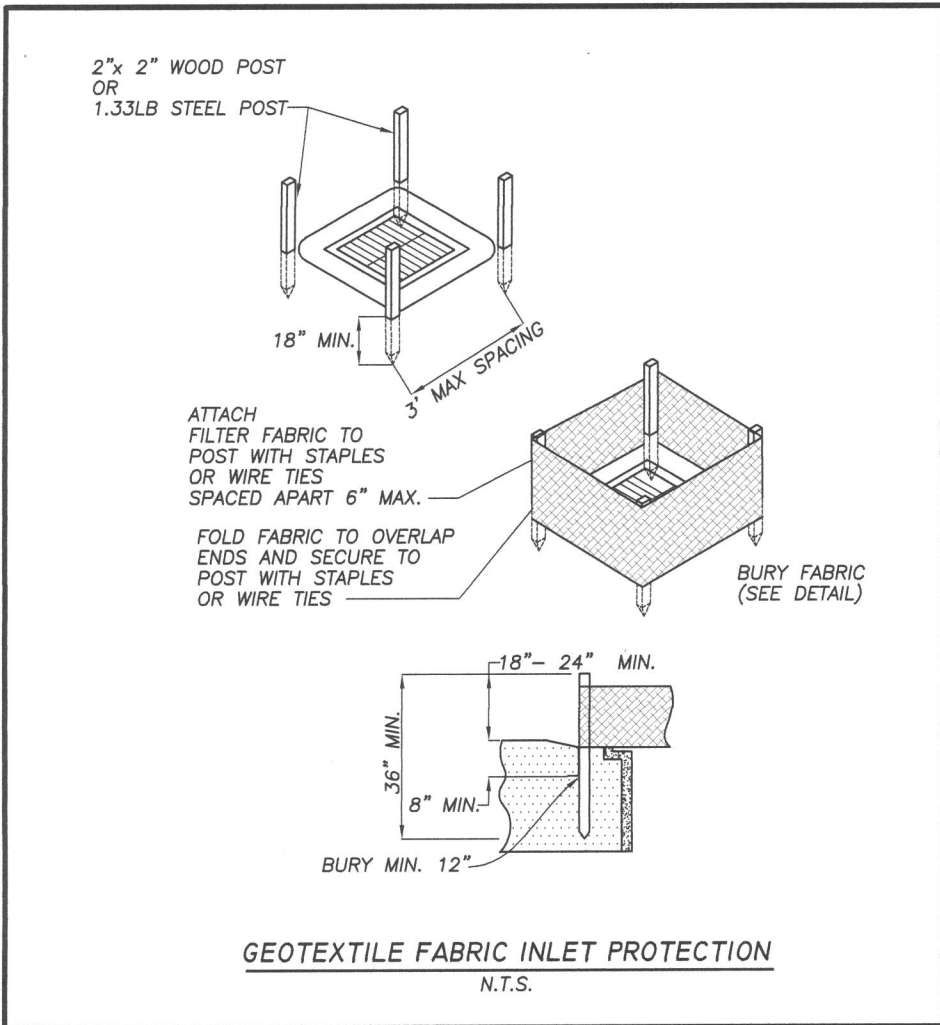

Note: The erosion control measures will be maintained weekly and after every storm event.

| START DAY | END DAY | SOIL EROSION CONTROL SEQUENCE OF CONSTRUCTION                    |
|-----------|---------|--|
| 1         | 2       | INSTALL FILTER FABRIC SILT FENCE PRIOR TO START OF CONSTRUCTION. |
| 2         | 3       | STRIP AND STOCKPILE TOPSOIL IN DESIGNATED AREAS.                 |
| 4         | 5       | MASS GRADE SITE AS REQUIRED                                      |
| 6         | 10      | PLACE INLET FILTERS  |
| 10        | 15      | INSTALL UNDERGROUND UTILITIES (SANITARY, STORM, WATER MAIN)      |
| 16        | 17      | INSTALL ALL PUBLIC UTILITIES (ELECTRIC, TELEPHONE, CABLE TV)     |
| 18        | 22      | STABILIZE ROAD RIGHT OF WAY                                      |
| 23        | 27      | INSTALL PAVEMENT COMPLETE  |
| 27        | 30      | ESTABLISH VEGETATION FOR ALL DISTURBED AREAS                     |

| STREET CLEANING SCHEDULE |        |        |         |           |          |        |          |
|--------------------------|--------|--------|---------|-----------|----------|--------|----------|
|                          | SUNDAY | MONDAY | TUESDAY | WEDNESDAY | THURSDAY | FRIDAY | SATURDAY |
| SCRAPE STREET            |        | X      | X       | X         | X        | X      | X        |
| SWEEP STREET             |        |        |         | X         |          |        |          |

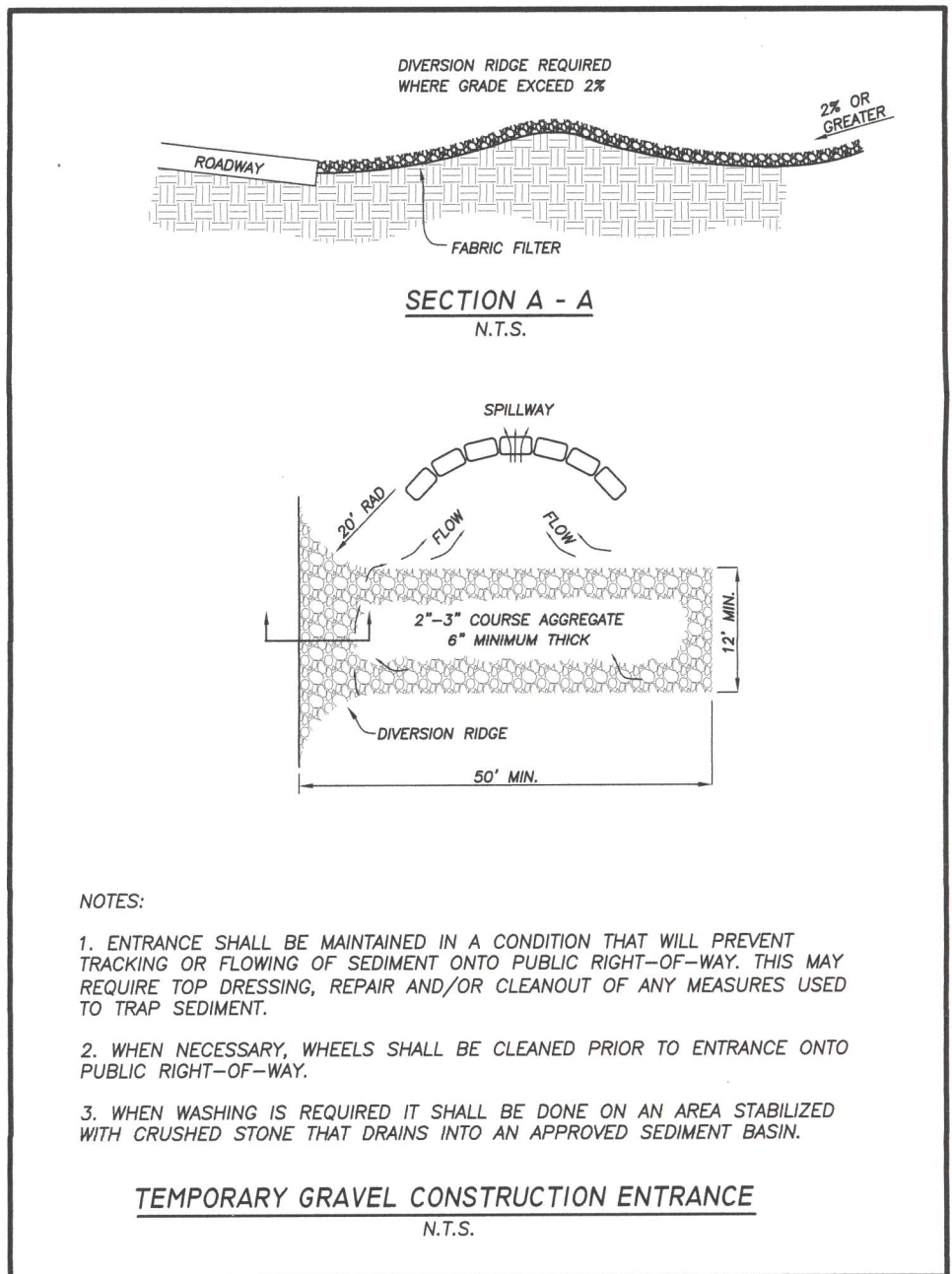
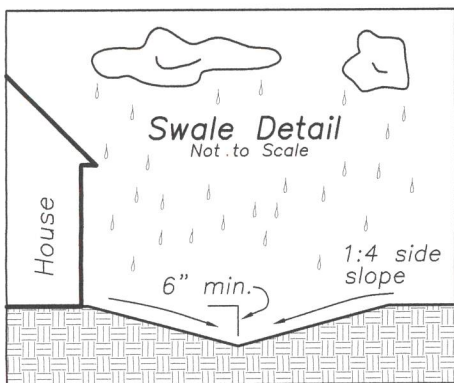

## EROSION CONTROL PLAN

prepared for: Cambridge Homes, Inc.  
47765 Bellagio Drive  
Northville, MI 48167  
(248) 348-3800

**JEKABSON & ASSOCIATES, P.C.**  
Professional Land Surveyors  
1320 Goldsmith, Plymouth, MI 48170  
(734) 414-7200 (734) 414-7272 fax



DATE  
21 April 21

JOB NO.  
16-05-020

SCALE  
N/A

DRAWN  
JRN

CHECKED  
JGE

SHEET  
2 OF 2

**WOODLAND  
REVIEW**



Corporate Headquarters  
295 South Water Street, Suite 300  
Kent, OH 44240  
800-828-8312

Local Office  
3381 Lapeer Rd. West  
Auburn Hills, MI 48326

**To:** Katherine Oppermann, Account Clerk  
Community Development Department, City of Novi

**From:** Kerry Gray, Principal Consultant  
Davey Resource Group

**CC:** Lindsay Bell, City of Novi Senior Planner  
Christian Carroll, City of Novi Planner  
Rick Meader, City of Novi Landscape Architect  
Madeleine Daniels, City of Novi Planning Assistant  
Barbara McBeth, City of Novi City Planner  
Angela Sosnowski, City of Novi Bond Coordinator  
Patricia Deering, City of Novi Account Clerk  
Heather Gendron, Spalding DeDecker  
Ted Meadows, Spalding DeDecker  
Sydney Waynick, Spalding DeDecker  
Craig Willey, The Mannik & Smith Group, Inc.

**Date:** July 7, 2021

**RE:** 48810 Castello Ct. Single Family Residential Plot Plan (Lot 23 Tuscany Reserve II)  
Woodland Review #2 - PBR21-0229

---

Davey Resource Group, Inc. (“DRG”) has conducted a review of the Single-Family Residential Plot Plan for 48810 Castello Ct. prepared by Jekabson & Associates, P.C. (received by the City of Novi: 06/28/2021). DRG reviewed the plan for conformance with the City of Novi’s Woodland Protection Ordinance, Chapter 37 and Revised Woodland Review #1.

The plan proposes the construction of a new single-family residence and future pool at 48810 Castello Ct. (Lot 23 Tuscany Reserve II) Parcel 22-32-376-023 which contains City-regulated woodlands (Figure 1).

**Recommendation:** DRG **recommends approval** of the 48810 Castello Ct. Residential Plot Plan contingent upon addressing the Woodland Review comments.

The following Woodland Regulations apply to this site:

| Woodland Regulation                                | Required |
|--|----------|
| Woodland Permit (Chapter 37, Section 37-26)        | YES      |
| Tree Replacement (Chapter 37, Section 37-8)        | YES      |
| Tree Protection (Fence) (Chapter 37, Section 37-9) | YES      |
| Woodland Conservation Easement (Chapter 37-30 (e)) | YES      |

**Woodland Impacts**

City of Novi regulated woodlands cover approximately 90% of the site. Trees regulated by the City of Novi (Chapter 37) include those that are 8-inches or greater DBH (diameter at breast height, 4.5-feet above existing grade) located within a regulated woodland and any tree 36-inches or greater DBH, irrespective of whether it is located in a regulated woodland. The construction **proposes the removal of 26 regulated woodland trees.**

**A Woodland Use Permit is required** to perform construction on any site containing regulated woodlands. The permit for this site **requires Planning Commission approval** because there are more than 3 trees proposed to be impacted/removed by construction.

**Woodland Review Comments:**

1. No trees were proposed to be cleared on this site as part of the approved Site Plan and Woodland Use Permit for the Tuscany Reserve Subdivision. The applicant is responsible for tree replacement credits for all trees proposed to be removed on the site for construction of the home and future pool plus 10 replacement credits that are required per the approved site plan and Woodland Use Permit for the Tuscany Reserve subdivision (WD08-0001).
2. **Tree Replacement Credits.** This site will use the remaining 40.5 Extra Woodland Replacement credits (see Revised Woodland Review #1) for the Tuscany Reserve II Subdivision. With the use of these credits Cambridge Homes has zero (0) remaining Extra Woodland Replacement Credits.

**For this site there are 16.5 Woodland Replacement Credits required** after using the 40.5 extra Woodland Replacement Credits that Cambridge Homes has remaining. The following chart summarizes the woodland tree removals and replacement credits required for 48810 Castello Ct.

| <b>WOODLAND REPLACEMENT CALCULATIONS</b>   |                                |                                       |                                    |   |
|--|--------------------------------|---------------------------------------|------------------------------------|---|
| <b>Tree Size (DBH)</b>   | <b>Number of Trees Removed</b> | <b>Ratio Replacement/Removed Tree</b> | <b>Total Replacements Required</b> | <b>Extra Woodland Replacement Credits</b> |
| 8-11"  | 12                             | 1                                     | 12                                 |   |
| 12-20"   | 10                             | 2                                     | 20                                 |   |
| 21-29"   | 2                              | 3                                     | 6                                  |   |
| 30+"   | 1                              | 4                                     | 4                                  |   |
| Multi-Stem   | 1                              | Add Stems/8                           | 5                                  |   |
| Tree Replacements Required per Approved Tuscany Reserve II Site Plan and Woodland Use Permit |                                |                                       | 10                                 |   |
| <b>Total</b>   |                                |                                       | 57                                 | 40.5                                      |
| <b>Total Replacements Credits (Required Replacements less Preservation Credits)</b>          |                                |                                       | <b>16.5</b>                        |   |

3. **Tree Replacement.** The 16.5 Woodland Replacement Credits will be planted on site “per the homeowner’s landscape plan.”
  - a. All trees proposed to be used to meet Woodland Replacement Credits **shall be approved by the**

**City of Novi** and meet the requirements in Chapter 37, Section 37-8 - *Relocation or replacement of trees*, including:

- Replacement trees shall be Michigan native species and a minimum of 2.5” caliper or greater in size. A list of suitable species is provided in this review memo.
  - Replacement trees should not be located 1) within 10’ of built structures or the edges of utility easements and 2) over underground structures/utilities or within their associated easements. In addition, replacement tree spacing should follow the Plant Material Spacing Relationship Chart for Landscape Purposes found in the City of Novi Landscape Design Manual.
- b. **If all tree replacement credits cannot be planted on site**, a payment of \$400 per tree not being planted on site shall be paid into the City of Novi Tree Fund.
4. **Financial Guarantees and City of Novi Tree Fund.** The following Financial Guarantees and/or payment to the City of Novi Tree Fund are required and shall be paid prior to issuance of a Woodland Permit.
- a. A financial guarantee, in the **amount of \$750 is required for tree protection fencing maintenance** per Chapter 26.5-37. This guarantee shall be paid prior to issuance of the City of Novi Woodland Use Permit.
  - b. A financial guarantee to secure the planting of required woodland replacement trees shall be required at a rate of \$400 per replacement tree planted on site. **The Financial Guarantee required for this site is \$6,800** (\$400 x 17 replacement credits).
  - c. A payment to the City of Novi in the amount of \$400 per tree is required for any woodland mitigation credits that are not planted on site.



Figure 1. 48810 Castello Ct.  
City of Novi Regulated Woodland Map

## Woodland Tree Replacement Chart

(from Chapter 37 Woodlands Protection) - Revised 5/7/2018

(All canopy trees to be 2.5" cal or larger, evergreens as listed)

| Common Name                         | Botanical Name                                 |
|-------------------------------------|--|
| Black Maple                         | <i>Acer nigrum</i>                             |
| Striped Maple                       | <i>Acer pennsylvanicum</i>                     |
| Red Maple                           | <i>Acer rubrum</i>                             |
| Sugar Maple                         | <i>Acer saccharum</i>                          |
| Mountain Maple                      | <i>Acer spicatum</i>                           |
| Ohio Buckeye                        | <i>Aesculus glabra</i>                         |
| Downy Serviceberry                  | <i>Amelanchier arborea</i>                     |
| Smooth Shadbush                     | <i>Amelanchier laevis</i>                      |
| Yellow Birch                        | <i>Betula alleghaniensis</i>                   |
| Paper Birch                         | <i>Betula papyrifera</i>                       |
| American Hornbeam                   | <i>Carpinus caroliniana</i>                    |
| Bitternut Hickory                   | <i>Carya cordiformis</i>                       |
| Pignut Hickory                      | <i>Carya glabra</i>                            |
| Shagbark Hickory                    | <i>Carya ovata</i>                             |
| Northern Hackberry                  | <i>Celtis occidentalis</i>                     |
| Eastern Redbud                      | <i>Cercis canadensis</i>                       |
| Pagoda Dogwood                      | <i>Cornus alternifolia</i>                     |
| Flowering Dogwood                   | <i>Cornus florida</i>                          |
| American Beech                      | <i>Fagus grandifolia</i>                       |
| Thornless Honeylocust               | <i>Gleditsia triacanthos inermis</i>           |
| Kentucky Coffeetree                 | <i>Gymnocladus dioica</i>                      |
| Walnut                              | <i>Juglans nigra</i> or <i>Juglans cinerea</i> |
| Eastern Larch                       | <i>Larix laricina</i>                          |
| Tuliptree                           | <i>Liriodendron tulipifera</i>                 |
| Tupelo                              | <i>Nyssa sylvatica</i>                         |
| American Hophornbeam                | <i>Ostrya virginiana</i>                       |
| White Spruce_(1.5:1 ratio) (6' ht.) | <i>Picea glauca</i>                            |
| Black Spruce_(1.5:1 ratio) (6' ht.) | <i>Picea mariana</i>                           |
| Red Pine_(1.5:1 ratio) (6' ht.)     | <i>Pinus resinosa</i>                          |
| White Pine_(1.5:1 ratio) (6' ht.)   | <i>Pinus strobus</i>                           |
| American Sycamore                   | <i>Platanus occidentalis</i>                   |
| Black Cherry                        | <i>Prunus serotina</i>                         |
| White Oak                           | <i>Quercus alba</i>                            |
| Swamp White Oak                     | <i>Quercus bicolor</i>                         |
| Scarlet Oak                         | <i>Quercus coccinea</i>                        |
| Shingle Oak                         | <i>Quercus imbricaria</i>                      |
| Burr Oak                            | <i>Quercus macrocarpa</i>                      |
| Chinkapin Oak                       | <i>Quercus muehlenbergii</i>                   |
| Red Oak                             | <i>Quercus rubra</i>                           |
| Black Oak                           | <i>Quercus velutina</i>                        |
| American Basswood                   | <i>Tilia americana</i>                         |



**WETLAND  
REVIEW**



July 7, 2021

Katherine Oppermann  
Account Clerk  
Department of Community Development  
City of Novi  
45175 W. Ten Mile Road  
Novi, Michigan 48375

RE: 48810 Castello Court / Tuscany Court Lot 23, PBR21-0229  
Wetland Review of Site Plan, First Revision  
MSG Project No. N1030037

Dear Ms. Oppermann:

The Mannik & Smith Group, Inc. (MSG) reviewed the revised "Grading Plan" for lot 23 of the Tuscany Reserve subdivision prepared by Jekabson & Associates, P.C., dated April 21, 2021, revised June 24, 2021, stamped "Received" by the City of Novi on June 28, 2021 (Site Plan). The project site is located north of Eight Mile Road and west of Garfield Road in Section 32. The address and parcel number associated with the project site are 48810 Castello Court and 50-22-32-376-023 (Site). MSG previously visited the Site and reviewed a previous version of the Site Plan, as described in MSG's letter dated May 13, 2021.

### **Proposed Impacts and MSG Recommendations**

The Site Plan proposes to limit construction to outside an identified wetland area and its associated 25-foot setback buffer and "wetland preservation easement". The following recommendations were provided in the May 13, 2021 letter and each still apply.

1. MSG recommends the applicant retain a qualified wetland consultant to verify and mark the limits of the offsite wetland, the 25-foot setback buffer, and the wetland preservation easement to facilitate their proper protection prior to the initiation of construction activities. The marker flags should remain in place throughout construction activities.
2. All silt fence and tree protection fence must remain in place and in good repair throughout construction activities.
3. The existing forest likely provides significant benefit to songbirds, small mammals, and other wildlife. MSG recommends the applicant look for adjustments to the Site Plan to further reduce impacts to the existing natural features.

### **Permits and Regulatory Status**

Based on available information, neither a wetland permit nor Authorization to Encroach into the Natural Features Setback are required for the proposed construction. ***MSG currently recommends approval of the Site Plan for Wetlands.***



Sincerely,

**The Mannik & Smith Group, Inc.**



Douglas Repen

*Environmental Scientist*

*Certified Storm Water Management Operator C-20319*



Craig S. Willey

*Project Manager*

CC: Lindsay Bell, City of Novi Planner  
Christian Carroll, City of Novi Planner  
Madeleine Daniels, City of Novi Planning Assistant  
Patricia Deering, City of Novi Account Clerk  
Rick Meader, City of Novi Landscape Architect  
Angela Sosnowski, City of Novi Bond Coordinator  
Heather Gendron, Spalding DeDecker  
Ted Meadows, Spalding DeDecker  
Sydney Waynick, Spalding DeDecker  
Mark F. Guidobono, Meg Development Company LLC  
Rick Corrent, Cambridge Homes Inc.