

cityofnovi.org

CITY of NOVI CITY COUNCIL

Agenda Item 3
March 11, 2013

SUBJECT: Approval of the request of Sun Vally, Ltd. for GFS Marketplace JSP12-71, for the Preliminary Site Plan, Special Land Use and Stormwater Management Plan. The subject property is located south of Twelve Mile Road and west of Donelson Drive in the RC, Regional Center District. The subject property is 2.15 acres and the applicant is proposing an approximately 16,000 square foot GFS Marketplace retail store at the Twelve Mile Crossing at Fountainwalk Shopping Center.

Bans

SUBMITTING DEPARTMENT: Community Development Department - Planning

CITY MANAGER APPROVAL:

BACKGROUND INFORMATION:

The applicant is proposing to construct a 16,000 square foot GFS Marketplace retail store on an outlot near the northeast corner of the Twelve Mile Crossing at Fountain Walk shopping center. This 2.15 acre area had been set aside for future development when the site was initially developed as a shopping center.

A free-standing retail store is permitted in the RC, Regional Center Zoning District when it is part of a planned commercial shopping center. Approval is subject to a number of conditions, including the standards for Special Land Use approval. A Community Impact Statement and Traffic Study are required (regardless of site size). In this case, the applicant is requesting a waiver of both documents. Staff supports the waiver of the Community Impact Statement, given the relatively small amount of retail space being added when compared to the existing retail space in the area.

Staff supports the wavier of the Traffic Study, consistent with the waiver standards of the ordinance:

- a. The existing Level of Service (LOS) along roadways will not drop below LOS C as a result of the proposed development;
- b. The existing LOS along roadways will not be significantly impacted by the proposed development;
- c. A similar Traffic Study was previously prepared and approved for the site.

The applicant has proposed splitting the parcel off from the larger 67.21 acre shopping center parcel following site plan approval. In anticipation of the parcel split, the Planning review has noted that the applicant will need to receive variances from the Zoning Board of Appeals for deficient building setbacks (100 feet required, 65 feet provided in the eastern yard, and 28 feet provided in the southern yard). A related variance for deficient parking lot setbacks in the same yards will also be required, due to the continuation of the parking areas with the shopping center development. The applicant has indicated that while it is the intention to split the parcel for ownership purposes, the new store will use existing curb cuts and driveway access within the existing Twelve Mile Crossing at Fountainwalk development.

The applicant is also seeking a Section 9 Façade Waiver for the overage of C-brick and split-faced CMU, and the underage of brick on the building. Prior to the Planning Commission meeting, the City's façade consultant recommended support of the waiver provided that additional articulation and interest is provided on the east and west building facades. The applicant has submitted revised elevations which are included in the packet as color renderings.

The following items have been changed and /or added since the Planning Commission's review of the matter:

- The parapet on the east wall was raised in the middle three bays and a brick soldier course was added.
- The parapet in the middle panel of the west wall was raised and a brick soldier course was added on the panels on either side of the middle panel.
- A brick soldier course was added to two panels on the north wall.

Staff believes the proposed changes add articulation and adequate visual interest to the facades in question so as to meet the recommendation of the Planning Commission.

The Planning Commission held the required public hearing on the Preliminary Site Plan, Special Land Use and Storm Water Management plan and has recommended approval of all three items. Relevant meeting minutes are attached.

RECOMMENDED ACTION: The following 3-part motion is recommended:

Part 1

Approval of the Special Land Use permit, based on and subject to the following:

- a. Based on this City Council finding under Section 2516.2.c for the Special Land Use permit that, relative to other feasible uses of the site:
 - The proposed use will not cause any detrimental impact on existing thoroughfares as noted in the traffic review letter.
 - The proposed use is compatible with adjacent uses of land in terms of location, size, character, and impact on adjacent property or the surrounding neighborhood due to the fact that the proposed retail store will not generate a substantial amount of noise or adverse impacts.
 - The proposed use is consistent with the goals, objectives and recommendations of the City's Master Plan for Land Use.
 - The proposed use will promote the use of land in a socially and economically desirable manner.
 - The proposed use is in harmony with the purposes and conforms to the applicable site design regulations of the zoning district in which it is located as noted in the staff review letters; and
- b. Subject to compliance with all conditions and requirements listed in the staff and consultant review letters.
- c. Based on and subject to the special land use and related site plan being in compliance with all applicable provisions of the Zoning Ordinance, including Articles 17, 24 and 25, and all applicable City Zoning Ordinance approvals, decisions, conditions and permits.

Part 2

Approval of the Preliminary Site Plan based on, with, and subject to the following:

- a. Subject to Applicant receiving variances from the Zoning Board of Appeals for the deficient building setbacks (100' required, 65' provided in eastern yard and 28' provided in southern yard);

- b. Subject to Applicant receiving variances from the Zoning Board of Appeals for the deficient parking setbacks (10' required, 4' provided in western yard and 3' provided in southern yard);
- c. With this City Council waiver of the required Traffic Study as the existing LOS along roadways will not be significantly impacted by the proposed development;
- d. Subject to Applicant providing an additional landscape island so that no more than 15 contiguous parking spaces are provided;
- e. With this City Council waiver to allow relocated foundation landscaping provided additional plantings are shown along the north and east sides of the building as indicated in the supplementary landscape plan provided;
- f. With this Section 9 façade waiver for the overage of C-brick and split-faced C.M.U. and underage of brick given that the fact that additional articulation has been added to the east, west and north facades as indicated in the supplementary building elevations provided; and
- g. Subject to the conditions and items listed in the staff and consultant review letters being addressed on the Final Site Plan.
- h. Based on and subject to the site plan and site being in compliance with all applicable provisions of the Zoning Ordinance, including Articles 17, 24 and 25, and all applicable City Zoning Ordinance approvals, decisions, conditions and permits.

Part 3

Approval of the Storm water Management Plan, subject to the conditions and items listed in the staff and consultant review letters being addressed on the Final Site Plan. This motion is made because, with those items addressed, the Plan will be in compliance with Chapter 11 of the Code of Ordinances and all other applicable provisions of the Ordinance.

	1	2	Y	N
Mayor Gatt				
Mayor Pro Tem Staudt				
Council Member Casey				
Council Member Fischer				

	1	2	Y	N
Council Member Margolis				
Council Member Mutch				
Council Member Wrobel				

SITE PLAN / SUPPLEMENTARY LANDSCAPE PLAN

1/2 Mile Road Right of Way Planting Requirements:

Canopy or Evergreen Trees Required: 13
 Canopy or Evergreen Trees Provided: 13
 Sub-Canopy Trees Required: 20
 Sub-Canopy Trees Proposed: 20

Proposed Plant List

Quantity	Common Name	Latin Name	Planted Size	Root Ball
5	Red Sunset Maple	Acer rubrum 'Frankford'	3" cal.	B x B
5	Berberis Opuntia	Picea omorika	6" ht.	B x B
32	Little Leaf Linden	Tilia cordata	5" cal.	B x B
1	Jamberry	Amelanchier canadensis	21/2" cal. 7'-8" ht. multi-stem	B x B
48	Green Velvet Boxwood	Buxus Green Velvet	24" ht.	Container
38	Dark Horse Nelsola	Nelapsa Florida Dark Horse	5 gal.	Container
20	Little Harry Bee	Bee Virginia Spruce	5 gal.	Container

(Note: for ordinance purposes only, the landscape contractor is responsible for what is shown on the landscape plan.)

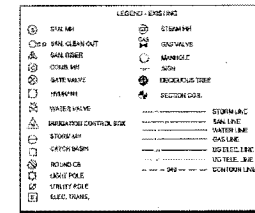
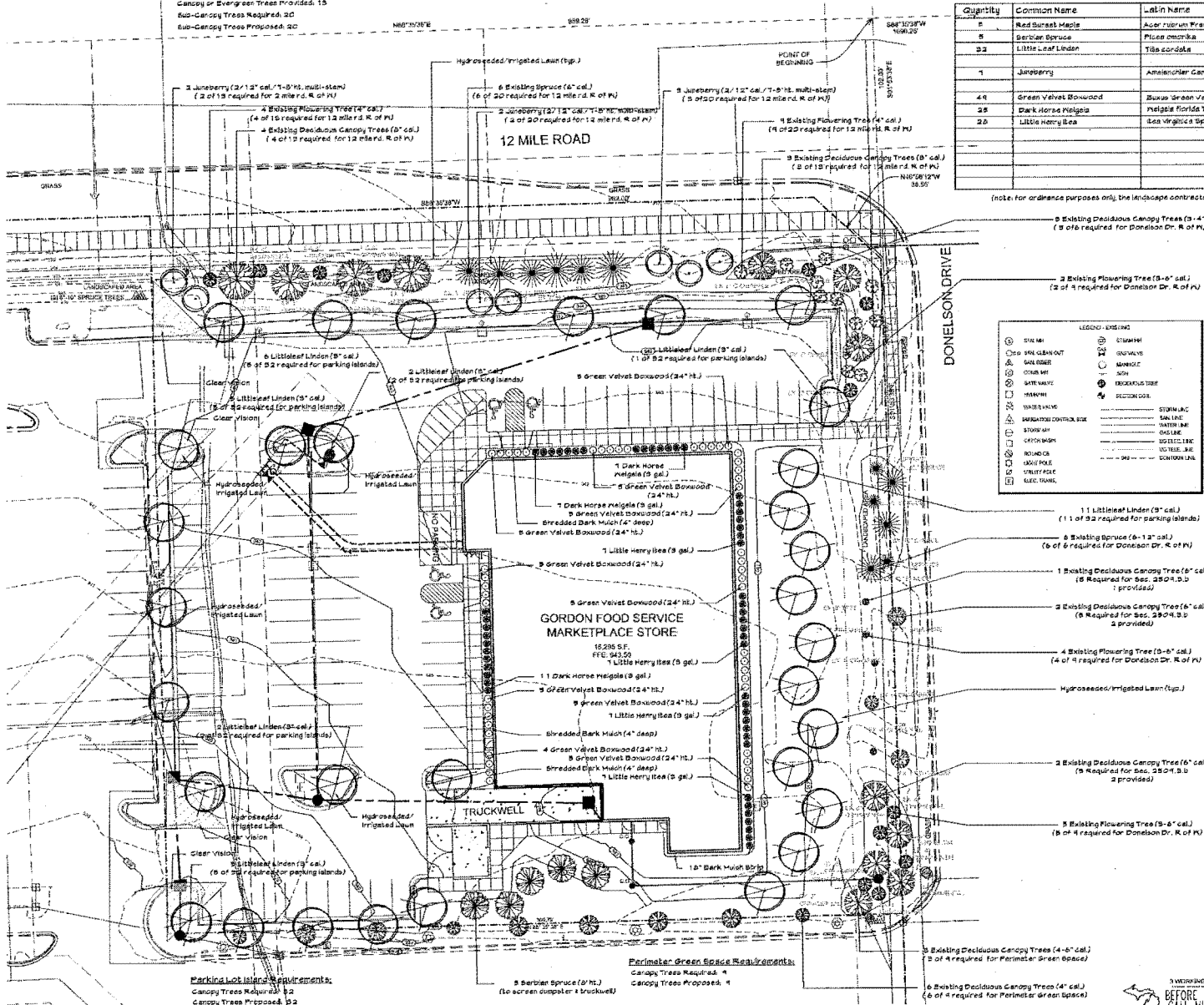

Joyce E. Polke

Joyce E. Polke
 7397 40th Ave.
 Hudsonville, Michigan 49426
 616-661-8024



NOTE:
 ALL UTILITIES SHOWN ARE APPROXIMATE.
 LANDSCAPE CONTRACTOR SHALL VERIFY ALL UTILITY
 INFORMATION. THE CONTRACTOR SHALL BE RESPONSIBLE FOR
 RESEARCH LOCATING NON-UTILITIES. THE CONTRACTOR SHALL BE
 RESPONSIBLE TO THE CITY UTILITIES IN THE AREA.

paradigm design
 550 3 MILE N.W.
 SUITE 1
 GRAND RAPIDS, MI 49544
 (616) 785 - 3656
 (616) 785 - 3657
 PARADIMAE.COM

PROJECT
GFS MARKETPLACE

NOVI
 LOCATED IN SECTION 13
 APPROX. 44225 W. 12 MILE RD
 NOVI, MICHIGAN

DEVELOPER:
GFS MARKETPLACE REALTY FIVE, LLC
 P.O. BOX 1812
 GRAND RAPIDS, MICHIGAN

PERMIT DATE
 2-26-13 Rev New City Review

PROJECT
1205049

SHEET
L 101

SUPPLEMENTARY ELEVATIONS

MAPS
Location
Zoning
Future Land Use
Natural Features

GFS Marketplace JSP12-71

Location

Twelve Mile Road

Subject Property

Donelson Drive

Map Author: Kristen Kapelanski
Date: 02/05/13
Project: GFS Marketplace JSP12-71
Version #: 1.0



City of Novi

Planning Division
Community Development
45175 W Ten Mile Rd
Novi, MI 48375
cityofnovi.org

MAP INTERPRETATION NOTICE

Map information depicted is not intended to replace or substitute for any official or primary source. This map was prepared to meet National Map Accuracy Standards and use the most recent available sources available to the people of the City of Novi. Boundary measurements and area calculations are approximate and should not be construed as survey measurements performed by a licensed Michigan Surveyor as defined in Michigan Public Act 132 of 1970 as amended. Please contact the City GIS Manager to confirm source and accuracy information related to this map.



1 inch = 91 feet

GFS Marketplace JSP12-71

Zoning

Twelve Mile Road



Donelson Drive

Map Author: Kristen Kapelanski
Date: 02/05/13
Project: GFS Marketplace JSP12-71
Version #: 1.0

Map Legend	
	OS-1: Office Service District
	RC: Regional Center District



City of Novi
Planning Division
Community Development
45175 W Ten Mile Rd
Novi, MI 48375
cityofnovi.org

MAP INTERPRETATION NOTICE
Map information depicted is not intended to replace or substitute for any official or primary source. This map was intended to meet National Map Accuracy Standards and use the most recent accurate sources available to the people of the City of Novi. Boundary measurements and area calculations are approximate and should not be construed as survey measurements performed by a licensed Michigan Surveyor as defined in Michigan Public Act 152 of 1970 as amended. Please contact the City GIS Manager to confirm source and accuracy information related to this map.

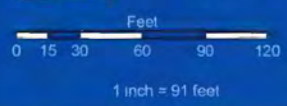

GFS Marketplace JSP12-71

Future Land Use

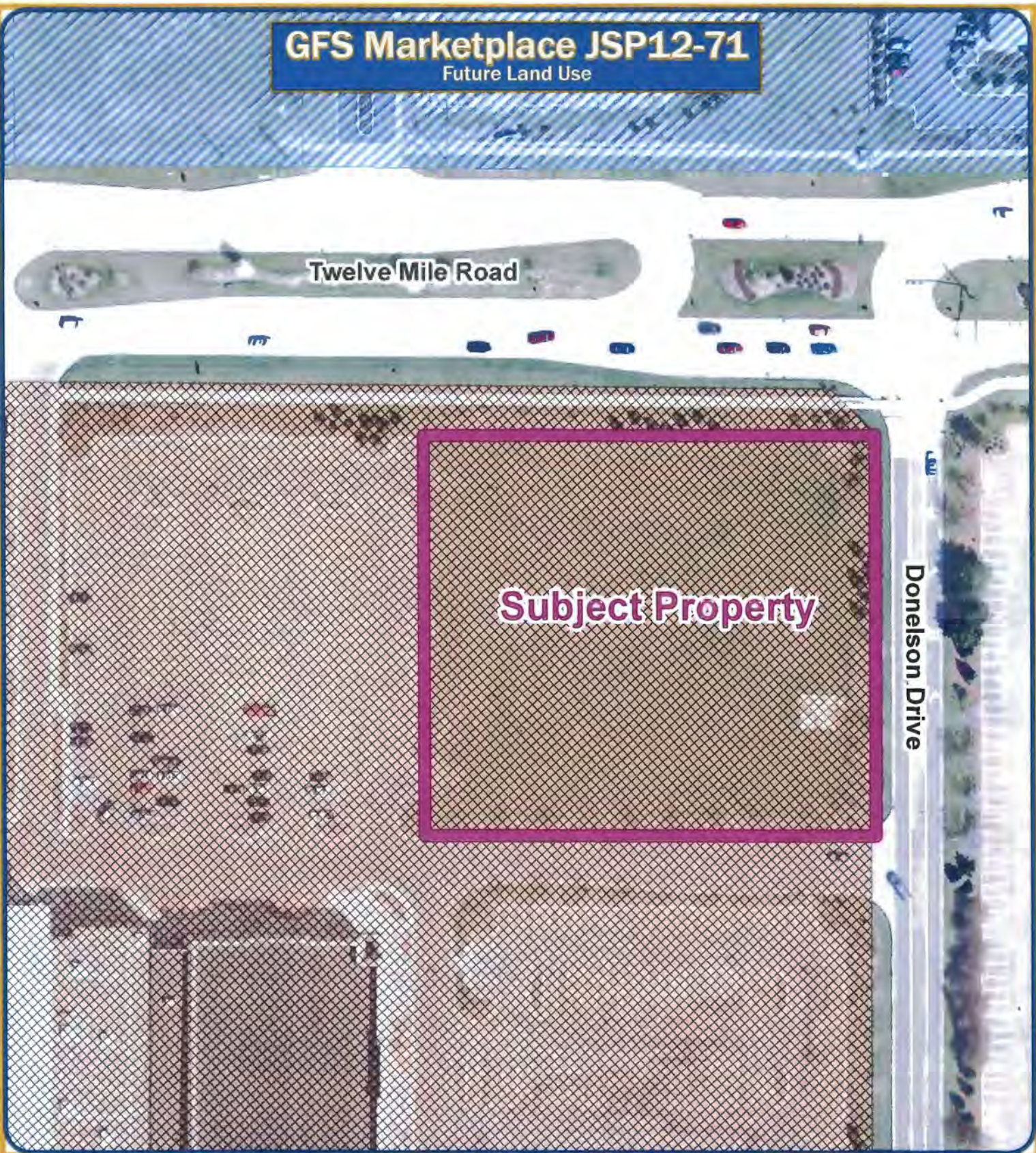

Twelve Mile Road

Donelson Drive

Subject Property

Map Author: Kristen Kapelanski
 Date: 02/05/13
 Project: GFS Marketplace JSP12-71
 Version #: 1.0

Map Legend	
	Community Office
	Regional Commercial



City of Novi
 Planning Division
 Community Development
 45175 W Ten Mile Rd
 Novi, MI 48375
 cityofnovi.org

MAP INTERPRETATION NOTICE
 Map information described is not intended to replace or substitute in any official or primary source. This map was intended to meet National Map Accuracy Standards and use the most recent accurate sources available to the people of the City of Novi. Boundary measurements and area calculations are approximate and should not be construed as survey measurements performed by a licensed Michigan Surveyor as defined in Michigan Public Act 233 of 1970 or otherwise. Please contact the City GIS Manager to confirm source and accuracy information related to this map.

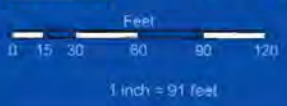

GFS Marketplace JSP12-71

Natural Features

Twelve Mile Road



Subject Property

Donelson Drive

Map Author: Kristen Kapelanski
 Date: 02/05/13
 Project: GFS Marketplace JSP12-71
 Version #: 1.0

MAP INTERPRETATION NOTICE
 Map information depicted is not intended to replace or substitute for any official primary source. This map was intended to meet National Map Accuracy Standards and use the most recent accurate sources available to the people of the City of Novi. Boundaries, measurements and area calculations are approximate and should not be construed as survey measurements, performed by a licensed Michigan Surveyor as defined in Michigan Public Act 132 of 1970, as amended. Please contact the City GIS Manager to confirm source and accuracy information related to this map.

Map Legend

	Wetlands
	Woodlands



City of Novi
 Planning Division
 Community Development
 45175 W Ten Mile Rd
 Novi, MI 48375
 cityofnovi.org

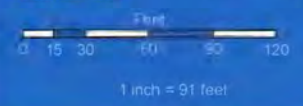

**EXCERPT FROM
MARCH 6, 2013 MEMO FROM
COMMUNITY DEVELOPMENT**

MEMORANDUM

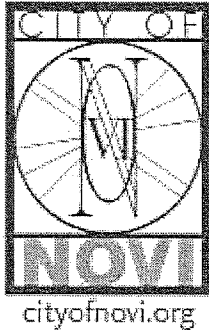

TO: CLAY PEARSON, CITY MANAGER
FROM: BARBARA MCBETH, AICP, DEPUTY DIRECTOR
OF COMMUNITY DEVELOPMENT
SUBJECT: UPDATES ON TWO DEVELOPMENT PROJECTS
DATE: MARCH 6, 2013

This memo is provided as an update on two development projects that have recently been reviewed and recommended by the Planning Commission, and which will be set for consideration by the City Council at an upcoming meeting. One project is the Island Lake "Meadows", a proposed 74-lot expansion to the Island Lake of Novi Residential Unit Development (RUD) for property near the northeast corner of Ten Mile and Wixom Roads. The second project is a GFS Marketplace retail store proposed for the northeastern outlot at the Twelve Mile Crossing at Fountainwalk Development.

Island Lake Meadows

Toll Brothers is proposing to add a 40.68 acre parcel near the northeast corner of Ten Mile and Wixom Roads to the existing Island Lake RUD in order to construct 74 single-family residential units. The proposed road system would connect to existing Acorn Trail to the north in "The Vineyards" Phase 3C of Island Lake, and provide a new road connection to Wixom Road directly across from Drakes Bay Drive. Please see attached plan. The applicant indicates this phase would be considered part of the Island Lake community, sharing the existing clubhouse, open space and recreational facilities with the remainder of the development. The proposed "Meadows" phase is directly adjacent to other phases of Island Lake to the north, and on the west side of Wixom Road.

Per the materials submitted in response to staff reviews, staff concurs that there are currently 784 units constructed or approved in the existing Island Lake development. The addition of 74 units would bring the total number of units to 858 units, which is still fewer than the amount permitted in the existing RUD Agreement (884 units). (Please note the planning review letter indicates 773 units have been constructed or approved in the existing development. This was later shown to be in error and 11 units short of the actual total.) With the addition of the 40.68 acre parcel, the Island Lake of Novi Development will consist of 956.7 acres in total. Slightly more than half (50.5%) of the total acreage of the Island Lake Development will be preserved as open space.

The City Council initially approved the Residential Unit Development in 1998. Lestlyde Lifesyles was the original applicant in the request (aka Levy Companies). Toll Brothers acquired the property and rights to develop shortly after the RUD was approved and is the applicant in the current request.

As an optional form of development, the RUD allows development flexibility of various types of residential dwelling units (one-family, attached one-family cluster). It is also the intent of the RUD option to permit permanent preservation of valuable open land, fragile natural resources and rural community character that would be lost under

conventional development. This is accomplished by permitting flexible lot sizes in accordance with open land preservation credits when the residential developments are located in a substantial open land setting, and through the consideration of relaxation of area, bulk, yard, dimensional and other zoning ordinance standards in order to accomplish specific planning objectives.

This flexibility is intended to reduce the visual intensity of development; provide privacy; protect natural resources from intrusion, pollution, or impairment; protect locally important animal and plant habitats; preserve lands of unique scenic, historic, or geologic value; provide private neighborhood recreation; and protect the public health, safety and welfare.

Such flexibility will also provide for:

- The use of land in accordance with its character and adaptability;
- The construction and maintenance of streets, utilities and public services in a more economical and efficient manner;
- The compatible design and use of neighboring properties; and
- The reduction of development sprawl, so as to preserve open space as undeveloped land.

Amendments and revisions to an approved RUD plan shall require all procedures and conditions that are required for original submittal and review for amendments that are considered "major changes". The addition of land area is considered a "major change", so full review of the ordinance standards is necessary at this time.

The ordinance states that an RUD shall include detached one-family dwelling units, as is proposed in this phase. The applicant has not proposed any attached units, clubhouses, churches, schools or other uses that may be permitted as a part of the proposed development phase. While a variety of housing types is expected in an RUD, the overall density generally shall not exceed the density permitted in the underlying zoning districts. The applicant has provided a statement that the proposed density will increase from 0.89 units/acre to 0.96 units/acre if the RUD Amendment is approved. The Island Lake Development is a combination of R-1, One Family Residential, and RA, Residential Acreage zoning.

Current Proposal to Add land to the Approved RUD

Late last year, the applicant submitted an RUD Plan, RUD Amendment and Preliminary Site Plan showing 75 single-family residential units. The Planning Commission held a public hearing on December 12, 2012 for the submitted RUD Plan. Relevant meeting minutes are attached. At that hearing several members of the public expressed concerns. Staff initially recommended denial of the plans due to a number of deficiencies in the submittal. Following the first staff review and the subsequent Planning Commission meeting, the applicant provided the required 'technical' items listed in the RUD ordinance, including a statement regarding the proposed mechanism to assure the permanent preservation and maintenance of open space areas and a large scale aerial photo of the area. The applicant also submitted a written explanation with exhibits that detailed how the proposed expansion would meet the standards and intent of the RUD Ordinance. Primarily due to deficiencies in the

application submittal requirements, the Planning Commission postponed consideration and adjourned the public hearing to a date to be determined.

The applicant subsequently submitted a revised RUD Plan, RUD Amendment and Preliminary Site Plan proposing 74 single-family units (1 fewer than previously proposed). The eliminated unit has been converted to open space and parkland and the applicant has offered to contribute \$25,000 to the Island Lake Homeowner's Association to be used for the expansion of the existing swimming pool deck. The applicant has also included several features to aid pedestrians, including a sidewalk connection to the proposed Dinser Drive sidewalk, a crosswalk on Wixom Road and the construction of approximately 928 feet of missing sidewalk within the Wixom Road right-of-way on the excluded property south of the proposed development.

Ordinance Standards for consideration of an RUD

Staff provided a number of comments in the review letters regarding the various criteria provided in the Zoning Ordinance for review of an RUD. The Planning Commission and the City Council are asked to weigh the items noted in the staff and consultant review letters against the standards of the ordinance when determining whether it would be appropriate to include the additional land into the approved Island Lake RUD. Given that staff is recommending approval of the inclusion of the subject property in the existing Island Lake RUD, it is staff's opinion that the applicant has met the ordinance requirements when the entire RUD is taken into account.

For example, the standards of the RUD ordinance seek to find a balance between traditional ordinance standards for lot area, width and setback requirements, natural features impacts, and the public interest:

"Whether any proposed deviations from the area, bulk, yard, and other dimensional requirements of the zoning ordinance applicable to the property enhance the development, are in the public interest, are consistent with the surrounding area, and are not injurious to the natural features and resources of the property and surrounding area."

In this case, the applicant is requesting deviations from ordinance standards to allow a reduced lot size and width and to allow a lesser side yard setback. Planning staff is of the opinion that the reduced lot size and width does not directly affect the natural features on the site any differently than traditional development under the current zoning. Additionally, both wetlands on the site are relatively small, with Wetland A being non-essential and not requiring any permits from the City for proposed impacts. The applicant has proposed to save the highest-quality trees (black walnuts along Dinser Drive) on the site at the request of the City. The applicant has met the requirements of the ordinance in order to remove other regulated trees on the site.

A second example from the ordinance relates to reduction in lot size and preservation of open space:

"Whether the proposed reductions in lot sizes and setback areas are the minimum necessary to preserve and create open space, to provide for school

and park sites, and to ensure compatibility with adjacent and neighboring land uses."

The applicant has proposed a reduction in lot size and width that is similar to a good portion of the lots within the existing Island Lake of Novi development. The proposed lot sizes would be compatible with the Island Lake Vineyards Phase 3C directly adjacent to and north of the subject property.

While more than 50 percent of the overall Island Lake property is maintained as "open space", the following open space calculations are provided solely for this phase (excluding required building setbacks buffer areas):

Ponds:	1.62 Acres
Pocket Park Area:	0.27 Acres
Perimeter, adjacent to the ponds and units 1-6, walk connections:	<u>3.09 Acres</u>
TOTAL OPEN SPACE:	4.98 Acres

This amounts to about 12 percent of the total area within the Island Lake Meadows Phase. As with the remainder of the Island Lake of Novi Development, the open space will ultimately be "owned" by the Homeowner's Association.

A third standard from the ordinance relates to the allowance for the increase in the total number of dwelling units permitted with RUD approval, when compared to conventional development:

"Whether any detrimental impact from the RUD resulting from an increase in total dwelling units over that which would occur with conventional residential development is outweighed by benefits occurring from the preservation and creation of open space and the establishment of school and park facilities that will result from the RUD."

The applicant has indicated that the total number of dwelling units provided with the addition of this phase is still within the total number allocated with the initial approval of the RUD (858 units planned or built, existing RUD agreement allows up to 884 units). Throughout the development of the Island Lake project, fewer units were built than originally contemplated. Toll Brothers subsequently acquired additional land that was not included in the initial RUD in order to accommodate the construction of additional homes in a couple of instances. A similar process of review and recommendation by the Planning Commission and approval by the City Council was followed to allow those phases to be added or altered. The proposal being presented at this time is to add additional land to further accommodate the density that was initially approved. While it is left to the discretion of the Planning Commission and City Council to weigh the standards of the ordinance against the relative benefit of the Conceptual plan, it is staff's opinion that the inclusion of the subject property into the existing Island Lake RUD is appropriate.

Planning Commission Recommendation

The Planning Commission held a second public hearing on February 13, 2013 and has recommended approval of the revised RUD plan. At an upcoming meeting, the City Council will be asked to consider whether the proposed additional phase may be

added to the approved Island Lake RUD. Ordinance standards for this discretionary decision will be included in the packet for the City Council's consideration. If the RUD Amendment is approved by the City Council, amended RUD documents will be considered for approval, followed by site plan approval in the usual course.

GFS Marketplace

The applicant is proposing to construct a 16,000 square foot GFS Marketplace retail store on an outlot near the northeast corner of the Twelve Mile Crossing at Fountain Walk shopping center. This 2.15 acre area had been set aside for future development when the site was initially developed as a shopping center. Please see the attached site plan.

A free-standing retail store is permitted in the RC, Regional Center Zoning District when it is part of a planned commercial shopping center. Approval is subject to a number of conditions, including the standards for Special Land Use approval. A Community Impact Statement and Traffic Study are required (regardless of site size). In this case, the applicant is requesting a waiver of both documents. Staff supports the waiver of the Community Impact Statement, given the relatively small amount of retail space being added when compared to the existing retail space in the area.

Staff supports the wavier of the Traffic Study, consistent with the waiver standards of the ordinance:

- a. The existing Level of Service (LOS) along roadways will not drop below LOS C as a result of the proposed development;
- b. The existing LOS along roadways will not be significantly impacted by the proposed development;
- c. A similar Traffic Study was previously prepared and approved for the site.

The applicant has proposed splitting the parcel off from the larger 67.21 acre shopping center parcel following site plan approval. In anticipation of the parcel split, the Planning review has noted that the applicant will need to receive variances from the Zoning Board of Appeals for deficient building setbacks (100 feet required, 65 feet provided in the eastern yard, and 28 feet provided in the southern yard). A related variance for deficient parking lot setbacks in the same yards will also be required, due to the continuation of the parking areas with the shopping center development. The applicant has indicated that while it is the intention to split the parcel for ownership purposes, the new store will use existing curb cuts and driveway access within the existing Twelve Mile Crossing at Fountainwalk development.

The applicant is also seeking a Section 9 Façade Waiver for the overage of C-brick and split-faced CMU, and the underage of brick on the building. Prior to the Planning Commission meeting, the City's façade consultant recommended support of the waiver provided that additional articulation and interest is provided on the east and west building facades. The applicant has submitted revised elevations which are included in the packet as color renderings.

The following items have been changed and /or added since the Planning Commission's review of the matter:



- The parapet on the east wall was raised in the middle three bays and a brick soldier course was added.
- The parapet in the middle panel of the west wall was raised and a brick soldier course was added on the panels on either side of the middle panel.
- A brick soldier course was added to two panels on the north wall.

Staff believes the proposed changes add articulation and adequate visual interest to the facades in question so as to meet the recommendation of the Planning Commission.

The Planning Commission held the required public hearing on the Preliminary Site Plan, Special Land Use and Storm Water Management plan and has recommended approval. The City Council will be asked to consider this request at an upcoming meeting.

- c Clay Pearson, City Manager
Victor Cardenas, Assistant City Manager
Charles Boulard, Community Development Director
Tom Schultz, City Attorney

**PLANNING COMMISSION
MEETING MINUTES – EXCERPT
FEBRUARY 13, 2013**

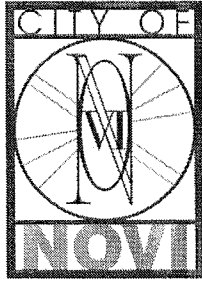

cityofnovi.org

PLANNING COMMISSION MINUTES

CITY OF NOVI

Regular Meeting

February 13, 2013 7:00 PM

Council Chambers | Novi Civic Center | 45175 W. Ten Mile
(248) 347-0475

CALL TO ORDER

The meeting was called to order at or about 7:00 PM.

ROLL CALL

Present: Member Greco, Member Lynch, Member Prince (arrived at 7:11), Member Gutman, Member Zuchlewski

Absent: Member Anthony, Chair Pehrson

Also Present: Barbara McBeth, Deputy Director of Community Development; Gary Dovre, City Attorney; Kristen Kapelanski, Planner; Mark Spencer, Planner; David Beschke, Landscape Architect; Adam Wayne, Engineer; Doug Necci, Façade Consultant; Rod Arroyo, Traffic Consultant

PLEDGE OF ALLEGIANCE

Member Lynch led the meeting attendees in the recitation of the Pledge of Allegiance.

APPROVAL OF AGENDA

Moved by Member Lynch, seconded by Member Zuchlewski:

VOICE VOTE ON THE AGENDA APPROVAL MOTION MADE BY MEMBER LYNCH AND SECONDED BY MEMBER ZUCHLEWSKI:

Motion to approve the February 13, 2013 Planning Commission Agenda. Motion carried 4-0.

PUBLIC HEARINGS

3. GFS MARKETPLACE, JSP12-71

Public hearing at the request of Sun Valley, Ltd. for a recommendation to City Council regarding the Preliminary Site Plan, Special Land Use and Stormwater Management Plan. The subject property is located in Section 15 south of Twelve Mile Road and west of Donelson Drive in the RC, Regional Center District. The subject property is 2.15 acres and the applicant is proposing an approximately 16,000 sq. ft. GFS Marketplace retail store.

Planner Kapelanski said the applicant is proposing to construct an approximately 16,000 sq. ft. GFS Marketplace retail store at the southwest corner of Twelve Mile Road and Donelson Drive, essentially as an 'outlot' of the existing Twelve Mile Crossing at Fountain Walk shopping center. The subject property is zoned RC, Regional Center and is bordered by RC zoning on all sides except to the north, which is zoned OS-1, Office Service. The Future Land Use map indicates Regional Commercial Uses for the subject property and most of the surrounding properties. The properties to the north are planned for Community Office uses. There are no natural features on the property. The applicant is proposing to split the subject property off of the existing Twelve Mile Crossing at Fountain Walk parcel and construct a GFS Marketplace retail store along with associated landscaping and parking.

The planning review recommends approval noting a Special Land Use Permit is required for stand-alone retail uses in the RC District. The Planning Commission should consider the factors listed in Section 2516.2.c of the Zoning Ordinance. The planning review also notes the applicant has elected to seek variances from the Zoning Board of Appeals for the deficient building setbacks and parking setbacks. The applicant is seeking a waiver of the required Traffic Study and Community Impact Statement. Both waivers are supported by the staff given the size of the proposed development in comparison to the larger shopping development and area in general, where the traffic and community impacts have been previously evaluated. The landscape review recommends approval of the plan. A waiver to allow more

than fifteen contiguous parking spaces would be required. Staff does not support this waiver and the applicant has indicated they will comply with the ordinance requirements. A waiver would also be required to allow the foundation landscaping to be relocated to another area of the site. The applicant has provided staff with a revised landscape plan showing additional landscaping on the east portion of the site. Staff finds the proposed additional landscaping to be acceptable and supports the requested waiver.

Planner Kapelanski continued noting the façade review recommends approval of the plan stating a Section 9 façade waiver is required for the overage of C-brick and split-faced C.M.U. and the underage of brick. Staff supports this waiver. The review also notes the applicant should provide additional architectural articulation and detail on the east and west facades, given the prominence of the proposed building at the intersection. The applicant has provided a revised elevation showing some additional detail but staff feels additional articulation is needed. The City's façade consultant is here to address any façade concerns. The engineering, traffic and fire reviews all recommend approval of the plan. Stand-alone retail buildings in the RC District must receive the approval of the City Council following review and recommendation from the Planning Commission.

Ryan Stysma of GFS Marketplace said they are excited about getting into the City of Novi and providing services here. We're looking forward to contributing to the overall development of what Fountain Walk is currently doing and trying to increase business.

Moved by Member Lynch and seconded by Member Prince:

ROLL CALL VOTE ON THE SPECIAL LAND USE PERMIT APPROVAL MOTION MADE BY MEMBER LYNCH AND SECONDED BY MEMBER PRINCE:

In the matter of GFS Marketplace, JSP12-71, motion to recommend approval of the Special Land Use permit, subject to the following:

a. Planning Commission finding under Section 2516.2.c for the Special Land Use permit, that relative to other feasible uses of the site:

- The proposed use will not cause any detrimental impact on existing thoroughfares, as noted in the traffic review letter;
- The proposed use is compatible with adjacent uses of land in terms of location, size, character, and impact on adjacent property or the surrounding neighborhood, due to the fact that the proposed retail store will not generate a substantial amount of noise or adverse impacts;
- The proposed use is consistent with the goals, objectives and recommendations of the City's Master Plan for Land Use;
- The proposed use will promote the use of land in a socially and economically desirable manner; and
- The proposed use is in harmony with the purposes and conforms to the applicable site design regulations of the zoning district in which it is located as noted in the staff review letters; and

b. Compliance with all conditions and requirements listed in the staff and consultant review letters.

This motion is made because the plan is otherwise in compliance with Article 17, Article 24 and Article 25 and all other applicable provisions of the Zoning Ordinance. *Motion carried 5-0.*

Moved by Member Lynch and seconded by Member Prince:

ROLL CALL VOTE ON THE PRELIMINARY SITE PLAN APPROVAL MOTION MADE BY MEMBER LYNCH AND SECONDED BY MEMBER PRINCE:

In the matter of GFS Marketplace, JSP12-71, motion to recommend approval of the Preliminary Site Plan subject to the following:

- a. Applicant receiving variances from the Zoning Board of Appeals for the deficient building setbacks (100' required, 65' provided in eastern yard and 28' provided in southern yard);
- b. Applicant receiving variances from the Zoning Board of Appeals for the deficient parking setbacks (10' required, 4' provided in western yard and 3' provided in southern yard);
- c. City Council waiver of the required Traffic Study as the existing level of service along roadways will not be significantly impacted by the proposed development;
- d. Applicant providing an additional landscape island so that no more than 15 contiguous parking spaces are provided;
- e. Applicant providing additional foundation landscaping as indicated in the supplementary landscape plan;
- f. Section 9 façade waiver for the overage of C-brick and split-faced C.M.U. and underage of brick, provided the applicant shows additional articulation on the east and west facades; and
- g. The conditions and items listed in the staff and consultant review letters being addressed on the Final Site Plan.

This motion is made because the plan is otherwise in compliance with Article 17, Article 24 and Article 25 of the Zoning Ordinance and all other applicable provisions of the Ordinance. *Motion carried 5-0.*

Moved by Member Lynch and seconded by Member Prince:

ROLL CALL VOTE ON THE STORMWATER MANAGEMENT PLAN APPROVAL MOTION MADE BY MEMBER LYNCH AND SECONDED BY MEMBER PRINCE:

In the matter of GFS Marketplace, JSP12-71, motion to recommend approval of the Stormwater Management Plan, subject to the conditions and items listed in the staff and consultant review letters being addressed on the Final Site Plan. This motion is made because it is other in compliance with Chapter 11 of the Code of Ordinances and all other applicable provisions of the Ordinance. *Motion carried 5-0.*

PLANNING REVIEW



PLAN REVIEW CENTER REPORT

January 16, 2013
Planning Review
GFS Marketplace
JSP12-71

Petitioner

Sun Vally, Ltd.

Review Type

Preliminary Site Plan and Special Land Use

Property Characteristics

- Site Location: South of Twelve Mile Road, west of Donelson Drive (Section 15)
- Site Zoning: RC, Regional Center
- Adjoining Zoning: North: OS-1, Office Service (across Twelve Mile Rd.); South and East: RC; West: OST, Planned Office Service Technology
- Current Site Use: Vacant outlot of Twelve Mile Crossing at Fountain Walk shopping center
- Adjoining Uses: North and West: Existing office; South and East: Shopping Center;
- School District: Novi Community District
- Existing Site Size: 67.21 acres
- Proposed Site Size: 2.15 acres
- Plan Date: 12-14-12

Project Summary

The applicant is proposing to construct an approximately 16,000 sq. ft. GFS Marketplace retail store on an existing outlot near the northeast corner of the Twelve Mile Crossing at Fountain Walk shopping center. The applicant has proposed splitting the parcel off from the larger shopping center parcel. Associated parking and landscaping would also be constructed.

Recommendation

Provided the applicant receives the necessary variances from the Zoning Board of Appeals, staff recommends approval of the Preliminary Site Plan and Special Land Use Permit. Considering the size of the undeveloped space in question, some of these variance requests may be unavoidable. In order to meet the building setbacks on all four sides of the proposed building, the applicant would have to reduce the size of the building by 30%. There are only minor planning related items to be addressed on the Final Site Plan submittal. There are more significant items to be addressed in the landscape and façade reviews. Prior to proceeding to the Planning Commission, the applicant should submit the relevant sheets for a revised Preliminary Site Plan review for façade and landscape only.

Ordinance Requirements

This project was reviewed for conformance with the Zoning Ordinance with respect to Article 17 (RC, Regional Center District), Article 24 (Schedule of Regulations), Article 25 (General Provisions) and any other applicable provisions of the Zoning Ordinance. Items in **bold** below must be addressed by the applicant.

1. Building Setbacks: Buildings must be setback 100 feet from all property lines. The proposed building is setback 65 feet along the east property line and 28 feet along the south property line. The applicant has elected to seek variances from the Zoning Board of Appeals for these deficiencies. **If the variances are not granted, plans will need to be modified to meet the ordinance standards.**
2. Parking Setback: Parking areas must be setback 10 feet along side and rear property lines. The proposed parking setback in the western side yard is 4 feet and the proposed setback in the southern rear yard is 3 feet. The applicant has elected to seek variances from the Zoning Board of

Appeals for these deficiencies. **If the variances are not granted, plans will need to be modified to meet the ordinance standards.**

3. Minor Items: There are several minor items noted in the planning review chart and lighting review chart. **The applicant should adjust the plans accordingly for the Final Site Plan submittal.**
4. City Council Approval: In the RC District, proposed developments on parcels over 4 acres in area must be approved by the City Council after the review and recommendation of the Planning Commission.
5. Parcel Split: The applicant has indicated and the plan shows a proposed parcel split. This must be completed before Stamping Sets can be stamped approved by the Planning Division.
6. Signage: Exterior Signage is not regulated by the Planning Division or Planning Commission. Please contact Jeannie Niland (248.347.0438) for information regarding sign permits.3

Special Land Use Considerations

In the RC District, a retail establishment whose principal activity is the sale of merchandise in an enclosed building falls under the Special Land Use requirements (Section 1702.1). Section 2516.2.c of the Zoning Ordinance outlines specific factors the Planning Commission shall consider in the review and recommendation to City Council of the Special Land Use Permit request:

- Whether, relative to other feasible uses of the site, the proposed use will cause any detrimental impact on existing thoroughfares in terms of overall volumes, capacity, safety, vehicular turning patterns, intersections, view obstructions, line of sight, ingress and egress, acceleration/deceleration lanes, off-street parking, off-street loading/unloading, travel times and thoroughfare level of service.
- Whether, relative to other feasible uses of the site, the proposed use will cause any detrimental impact on the capabilities of public services and facilities, including water service, sanitary sewer service, storm water disposal and police and fire protection to service existing and planned uses in the area.
- Whether, relative to other feasible uses of the site, the proposed use is compatible with the natural features and characteristics of the land, including existing woodlands, wetlands, watercourses and wildlife habitats.
- Whether, relative to other feasible uses of the site, the proposed use is compatible with adjacent uses of land in terms of location, size, character, and impact on adjacent property or the surrounding neighborhood.
- Whether, relative to other feasible uses of the site, the proposed use is consistent with the goals, objectives and recommendations of the City's Master Plan for Land Use.
- Whether, relative to other feasible uses of the site, the proposed use will promote the use of land in a socially and economically desirable manner.
- Whether, relative to other feasible uses of the site, the proposed use is (1) listed among the provision of uses requiring special land use review as set forth in the various zoning districts of this Ordinance, and (2) is in harmony with the purposes and conforms to the applicable site design regulations of the zoning district in which it is located.

Additional Requirements

In the RC District, there are additional requirements for enclosed retail establishments as noted in Section 1702.1. Namely, the proposed retail establishment should be part of an existing or developing planned commercial shopping center. The proposed GFS Marketplace would be located within the parking area of the existing 12 Mile Crossing at Fountain Walk shopping center and therefore considered a part of the shopping center. In addition, retail establishments are also subject to the site plan review requirements of Section 2404.4 of the ordinance. This would require the Preliminary Site Plan to receive a recommendation for approval or denial from the Planning Commission with City Council ultimately approving or denying the proposed plan.

Section 2406.4.A of the Zoning Ordinance outlines specific factors the Planning Commission and City Council shall consider in the review:

1. The plan meets all the requirements of Section 2516 of this Ordinance for Preliminary Site Plans and the requirements set forth in the City's Site Plan and Development Manual. *Deficiencies and appropriate relief remedies are indicated in the review letters.*
2. The plan satisfies the intent of the Special Land Use provisions as stated in Section 2516.2.c. *See the Special Land Use Considerations noted in this Plan Review Letter.*
3. The Community Impact Statement and Traffic Study are provided, regardless of site size, in accordance with the requirements set forth in the City's Site Plan and Development Manual. **The applicant should request a waiver of the Community Impact Statement.** *Waivers of the Community Impact Statement can be granted administratively by the staff and in this case, a waiver seems appropriate given the amount of retail space being added compared to the existing retail space in the area. The applicant should request a waiver of the Traffic Study by the City Council.* Staff would support this waiver. The City Council should consider the following factors when considering a waiver of the Traffic Study requirement:
 - a. The existing Level of Service (LOS) along roadways will not drop below LOS C as a result of the proposed development;
 - b. The existing LOS along roadways will not be significantly impacted by the proposed development;
 - c. A similar Traffic Study was previously prepared and approved for the site.
4. The plan satisfies the intent of this Section with respect to use of the land and principal and accessory use relationships within the site as well as with uses on adjacent sites.
5. That all existing or proposed streets, road, utilities and marginal access service drives, as are required, are correctly located on the site plan in accordance with the approved plans for these improvements. *See the attached Engineering Review Letter for additional information.*
6. The plan meets all the applicable standards of this Ordinance relative to height, bulk and area requirements, building setbacks, off-street parking and preliminary site engineering requirements. *See the attached Plan Review Chart for additional information.*
7. That there exists a reasonable harmonious relationship between the location of buildings on the site relative to buildings on lands in the surrounding area; that there is a reasonable architectural and functional compatibility between all structures on the site and structures within the surrounding area to assure proper relationships between:
 - a. The topography of the adjoining lands as well as that of the site itself including any significant natural or manmade features. *Minimal topography for adjacent properties is included in the Preliminary Site Plan package.*
 - b. The relationship of one building to another whether on-site or on adjacent land, i.e., entrances, service areas and mechanical appurtenances. *The applicant has adequately screened mechanical appurtenances and service areas from adjacent properties.*
 - c. The rooftops of buildings that may lie below street levels or from windows of higher adjacent buildings. *No buildings will lie below street levels.*
 - d. Landscape plantings, off-street parking areas and service drives on adjacent lands. *See the Landscape Review Letter for additional information.*
 - e. Compliance with street, road and public utility layouts approved for the area. *See the Engineering and Traffic Review Letters for additional information.*
 - f. The architecture of the proposed building including overall design and façade materials used. Architectural design and façade material are to be complimentary to existing or proposed buildings within the site and the surrounding area. It is not intended that contrasts in architectural design and use of façade materials is to be

discouraged, but care shall be taken so that any such contrasts will not be so out of character with existing building designs and façade materials so as to create an adverse effect on the stability and value of the surrounding area. See the *Façade Review Letter for additional information.*

Section 2406.4.B indicates the City Council shall review the proposed plan considering the Planning Commission's recommendation and the requirements of Section 2404.4.A. As part of its approval of the Preliminary Site Plan, the Council is permitted to impose conditions that are reasonably related to the purposes of this section and that will:

1. Insure that public services and facilities affected by a proposed land use or activity will be capable of accommodating increased services and facility loads caused by the land use or activity;
2. Protect the natural environment and conserving natural resources and energy;
3. Insure compatibility with adjacent use of land; and
4. Promote the use of land in a socially and economically desirable manner.

Site Addressing

The applicant should contact the Building Division for an address prior to applying for a building permit. Building permit applications cannot be processed without a correct address. The address application can be found on the Internet at www.cityofnovi.org under the forms page of the Community Development Department.

Please contact Jeannie Niland [248.347.0438] in the Community Development Department with any specific questions regarding addressing of sites.

Pre-Construction Meeting

Prior to the start of any work on the site, Pre-Construction (Pre-Con) meetings must be held with the applicant's contractor and the City's consulting engineer. Pre-Con meetings are generally held after Stamping Sets have been issued and prior to the start of any work on the site. There are a variety of requirements, fees and permits that must be issued before a Pre-Con can be scheduled. If you have questions regarding the checklist or the Pre-Con itself, please contact Sarah Marchioni [248.347.0430 or smarchioni@cityofnovi.org] in the Community Development Department.

Chapter 26.5

Chapter 26.5 of the City of Novi Code of Ordinances generally requires all projects be completed within two years of the issuance of any starting permit. Please contact Sarah Marchioni at 248-347-0430 for additional information on starting permits: The applicant should review and be aware of the requirements of Chapter 26.5 before starting construction.

Response Letter

A letter from either the applicant or the applicant's representative addressing comments in this and other review letters is required prior to consideration by the Planning Commission and with the next plan submittal.

If the applicant has any questions concerning the above review or the process in general, do not hesitate to contact me at 248.347.0586 or kkapelanski@cityofnovi.org.

Kristen Kapelanski, AICP, Planner

Planning Review Summary Chart
 GFS Marketplace Store JSP12-71
 Preliminary Site Plan
 Plan Dated: 12-14-12

Item	Required	Proposed	Meets Requirements?	Comments
Master Plan	Regional Commercial	Regional Commercial	Yes	
Zoning	RC	RC	Yes	
Use (Sec. 1701 and 1702)	Regional and Community shopping centers, Retail businesses, Sit-down restaurants	GFS retail store	Yes	Special Land Use Permit Required
Building Height (Sec. 2400)	Maximum 45 feet	28'6" to peak of roof	Yes	
Building Setbacks (Sec. 2400)				
Front (north)	100 feet	107 feet	Yes	
Exterior Side (east)	100 feet	65 feet	No	The applicant has applied for a variance from the Zoning Board of Appeals for the deficient setback.
Interior Side (west)	100 feet	126 feet	Yes	
Rear (south)	100 feet	28 feet	No	The applicant has applied for a variance from the Zoning Board of Appeals for the deficient setback.
Parking Setbacks (Sec. 2400)				
Front (north)	20 feet	52 feet	Yes	
Exterior Side (east)	20 feet	22 feet	Yes	
Interior Side (west)	10 feet	4 feet	No	The applicant has applied for variances from the Zoning Board of Appeals for the deficient setbacks.
Rear (south)	10 feet	3 feet		
Number of Parking Spaces (Sec. 2505)	Retail Space: 1 space/200 sq. ft. 15,670 sq. ft./200 = 78 spaces required	78 spaces provided	Yes	
Parking Space	9' x 19' parking	Minimum 9' x 17.5'	Yes	A 4" curb must be

Item	Required	Proposed	Meets Requirements?	Comments
Dimensions (Sec. 2506)	space dimensions and 24' wide drives for 90° spaces. 9' x 17' parking space dimensions permitted with a 4" curb	parking space dimensions and minimum 24' wide drives.		provided and indicated via a not wherever parking spaces are less than 19'.
Barrier Free Spaces (Barrier Free Code)	4 barrier free spaces (1 van accessible)	4 van accessible barrier free	Yes	
Barrier Free Space Dimensions (Barrier Free Code)	8' wide with a 5' wide access aisle (8' wide access aisle for van accessible)	8' wide with an 8' wide access aisle for van accessible	Yes	
Barrier Free Signs (Barrier Free Design Graphics Manual)	One barrier free sign is required per space.	Barrier free signs shown.	Yes	
Loading Spaces (Sec. 2507)	10 square feet per front foot of building = 103 x 10 = 1,030 sq. ft. All loading shall be in the rear yard or interior side yard if double fronted lot.	Adequate loading space provided via a truckwell in the rear yard	Yes	
Loading Space Screening (Sec. 2302A.1)	In the RC District, view of loading and waiting areas must be shielded from rights of way and adjacent properties.	Proposed loading will be below grade and screened by the building.	Yes	
Accessory Structure Setback-Dumpster (Sec. 2503)	Accessory structures should be setback a minimum of 10 feet from any building unless structurally attached to the building and setback the same as parking from all property lines; in addition, the	Dumpster located in the rear yard and setback appropriately from the building and property lines.	Yes	

Item	Required	Proposed	Meets Requirements?	Comments
	structure must be in the rear or interior side yard.			
Dumpster (Chap. 21, Sec. 21-145)	Screening of not less than 5 feet on 3 sides of dumpster required, interior bumpers or posts must also be shown. Enclosure to match building materials and be at least one foot taller than height of refuse bin.	Screening details provided as part of proposed elevations.	Yes?	Applicant should confirm screening will be provided on the north side of the dumpster.
Exterior Signs	Exterior Signage is not regulated by the Planning Department or Planning Commission.			<u>Please contact Jeannie Niland (248.347.0438).</u>
Exterior Lighting (Sec. 251.1)	Photometric plan and exterior lighting details needed at final site plan.	Lighting plan submitted	See lighting review chart.	
Sidewalks (City Code Sec. 1.1: 276(b))	An 8' wide sidewalk shall be provided along Twelve Mile Road as required by the City's Pedestrian and Bicycle Master Plan. Building exits must be connected to sidewalk system or parking lot.	Existing concrete walk along 12 Mile Road to remain. Additional sidewalk connection provided	Yes	

Prepared by Kristen Kapelanski, (248) 347-0586 or kkapelanski@cityofnovi.org

Lighting Review Summary Chart

GFS Marketplace JSP12-71

Plan Date: 12-14-12

Item	Required	Meets Requirements?	Comments
Intent (Section 2511.1)	Establish appropriate minimum levels, prevent unnecessary glare, reduce spillover onto adjacent properties, reduce unnecessary transmission of light into the night sky	Yes	
Lighting plan (Section 2511.2.a.1)	Site plan showing location of all existing and proposed buildings, landscaping, streets, drives, parking areas and exterior lighting fixtures	Yes	
Lighting Plan (Section 2511.2.a.2)	Specifications for all proposed and existing lighting fixtures including: <ul style="list-style-type: none"> ▪ Photometric data ▪ Fixture height ▪ Mounting & design ▪ Glare control devices ▪ Type and color rendition of lamps ▪ Hours of operation ▪ Photometric plan 	Yes	
Required conditions (Section 2511.3.a)	Height not to exceed maximum height of zoning district or 25 feet where adjacent to residential districts or uses.	Yes	
Required Notes (Section 2511.3.b)	<ul style="list-style-type: none"> - Electrical service to light fixtures shall be placed underground - No flashing light shall be permitted - Only necessary lighting for security purposes and limited operations shall be permitted after a site's hours of operation. 	Yes	
Required	Average light level of	Yes?	The applicant should

Item	Required	Meets Requirements?	Comments
conditions (Section 2511.3.e)	The surface being lit to the lowest light of the surface being lit shall not exceed 4:1.		provide the average to minimum ratio.
Required conditions (Section 2511.3.f)	Use of true color rendering lamps such as metal halide is preferred over high and low pressure sodium lamps.	Yes	
Minimum illumination (Section 2511.3.k)	<ul style="list-style-type: none"> - Parking areas- 0.2 min - Loading and unloading areas- 0.4 min - Walkways- 0.2 min - Building entrances, frequent use- 1.0 min - Building entrances, infrequent use- 0.2 min 	Yes	
Maximum illumination adjacent to Non-Residential (Section 2511.3.k)	When site abuts a non-residential district, maximum illumination at the property line shall not exceed 1 foot candles	Yes	
Cut off Angles (Section 2511.3.1(2))	All cut off angles of fixtures must be 90 degrees when adjacent to residential districts	Yes	

ENGINEERING REVIEW



cityofnovi.org

PLAN REVIEW CENTER REPORT

January 16, 2013

Engineering Review

GFS Marketplace

JSP12-0071

Petitioner

Sun Valley, LTD, Owner

Review Type

Preliminary Site Plan

Property Characteristics

- Site Location: S. of Twelve Mile and W. of Donelson Dr.
- Site Size: 2.15 acres
- Plan Date: December 14, 2012

Project Summary

- Construction of an approximately 16,295 square-foot building and associated parking. Site access would be provided by two access points to the adjacent parking lot to the west.
- Water service would be provided by a 1.5-inch domestic lead and a 6-inch fire lead to serve the building, along with an additional hydrant on a 6-inch main from the existing 8-inch water main.
- Sanitary sewer service would be provided by connecting to an existing 6" lead from the 12" sanitary on Donelson dr.
- Storm water would be collected by a single storm sewer collection system and discharged into the existing detention basins located S. of West Oaks within the ITC property.

Recommendation

Approval of the Preliminary Site Plan and Preliminary Storm Water Management Plan is recommended.

Comments:

The Preliminary Site Plan meets the general requirements of Chapter 11, the Storm Water Management Ordinance and the Engineering Design Manual with the following items to be addressed at the time of Final Site Plan submittal (further engineering detail will be required at the time of the final site plan submittal):

Additional Comments (to be addressed prior to the Final Site Plan submittal):

General

1. Provide a note on the plans that all work shall conform to the current City of Novi standards and specifications.
2. The City standard detail sheets are not required for the Final Site Plan submittal. They will be required with the Stamping Set submittal.
3. Provide the Warranty Deed for the Fountain Walk Drive Right-of-Way prior to stamping set submittal. This is a previously unresolved matter with parcel 50-22-15-200-100.
4. Label the ROW half width for Twelve Mile Rd and Donelson Dr on all plan sheets.

Water Main

5. Provide a 20 ft wide public easement over the proposed water main extension and fire hydrant.
6. Provide a profile for the proposed water main.
7. Three (3) sealed sets of revised utility plans along with the MDEQ permit application (1/07 rev.) for water main construction and the Streamlined Water Main Permit Checklist should be submitted to the Engineering Department for review, assuming no further design changes are anticipated. Utility plan sets shall include only the cover sheet, any applicable utility sheets and the standard detail sheets.

Storm Sewer

8. Provide a profile of the proposed storm sewer showing a minimum cover of 3 feet and all catch basin sumps and the 10-year hydraulic grade line.
9. Provide a 0.1 foot drop for every change in direction greater than 30 degrees.
10. Denote the location of all building roof leads with length, slope, material type, and diameter.

Storm Water Management Plan

11. The Storm Water Management Plan for this development shall be designed in accordance with the Storm Water Ordinance and Chapter 5 of the new Engineering Design Manual.
12. A minimum slope of 2% must be maintained in the proposed drainage ditch.
13. Specify the ultimate discharge point for flow carried by the drainage ditch.

Paving & Grading

14. Provide the sidewalk height adjacent to any the abutting parking stalls.
15. Provide top of curb and gutter elevations for the proposed parking lot.

Off-Site Easements

16. Provide an ingress/egress easement for two access points on the west side of the proposed parcel.
17. Provide a storm sewer easement for the off-site structure adjacent to the southwest corner of the proposed parcel
18. Provide a Surface Drainage Easement for any sheet flow that crosses proposed parcel bounds.

The following must be submitted at the time of Final Site Plan submittal:

19. A letter from either the applicant or the applicant's engineer must be submitted with the Final Site Plan highlighting the changes made to the plans addressing each of the comments listed above and indicating the revised sheets involved.
20. An itemized construction cost estimate must be submitted to the Community Development Department at the time of Final Site Plan submittal for the determination of plan review and construction inspection fees. This estimate should only include the civil site work and not any costs associated with construction of the building or any demolition work. **The cost estimate must be itemized** for each utility (water, sanitary, storm sewer), on-site paving, right-of-way paving (including proposed right-of-way), grading, and the storm water basin (basin construction, control structure, pretreatment structure and restoration).

The following must be submitted at the time of Stamping Set submittal:

21. A draft copy of the maintenance agreement for the storm water facilities, as outlined in the Storm Water Management Ordinance, must be submitted to the Community Development Department with the Final Site Plan. Once the form of the agreement is approved, this agreement must be approved by City Council and shall be recorded in the office of the Oakland County Register of Deeds.
22. An executed copy of the private ingress/egress easement for shared use of the parking lot to the west must be submitted to the Community Development Department.
23. An executed copy of the drainage easement with the adjacent property to the west must be submitted to the Community Development Department.
24. A draft copy of the 20-foot wide easement for the water main to be constructed on the site must be submitted to the Community Development Department.

25. A draft copy of the 20-foot wide easement for the sanitary sewer to be constructed on the site must be submitted to the Community Development Department.
26. Executed copies of any required off-site utility/construction easements must be submitted to the Community Development Department.

The following must be addressed prior to construction:

27. A pre-construction meeting shall be required prior to any site work being started. Please contact Sarah Marchioni in the Community Development Department to setup a meeting (248-347-0430).
28. A City of Novi Grading Permit will be required prior to any grading on the site. This permit will be issued at the pre-construction meeting. Once determined, a grading permit fee must be paid to the City Treasurer's Office.
29. A Soil Erosion Control Permit must be obtained from the City of Novi. Contact Sarah Marchioni in the Community Development Department (248-347-0430) for forms and information.
30. A permit for work within the right-of-way of Donelson Dr must be obtained from the City of Novi. The application is available from the City Engineering Department and should be filed at the time of Final Site Plan submittal. Please contact the Engineering Department at 248-347-0454 for further information.
31. A permit for work within the right-of-way of Twelve Mile Rd must be obtained from the Road Commission for Oakland County. Please contact the RCOC (248-858-4835) directly with any questions. The applicant must forward a copy of this permit to the City. Provide a note on the plans indicating all work within the right-of-way will be constructed in accordance with the Road Commission for Oakland County standards.
32. A permit for water main construction must be obtained from the MDEQ. This permit application must be submitted through the City Engineer after the water main plans have been approved.
33. A permit for sanitary sewer construction must be obtained from the MDEQ. This permit application must be submitted through the City Engineer after the sanitary sewer plans have been approved.
34. Construction Inspection Fees to be determined once the construction cost estimate is submitted must be paid prior to the pre-construction meeting.
35. An incomplete site work performance guarantee for this development will be calculated (equal to 1.5 times the amount required to complete the site improvements, excluding the storm water facilities) as specified in the Performance Guarantee Ordinance. This guarantee will be posted prior to TCO, at which time it may be reduced based on percentage of construction completed.

36. A street sign financial guarantee in an amount to be determined (\$400 per traffic control sign proposed) must be posted at the Treasurer's Office.
37. Permits for the construction of each retaining wall (if any) must be obtained from the Community Development Department (248-347-0415).

Please contact Adam Wayne at (248) 735-5648 with any questions.



cc: Ben Croy, Engineering
Brian Coburn, Engineering
Kristen Kapelanski, Community Development Department
Debra Peck, Water & Sewer Dept.

TRAFFIC REVIEW

January 8, 2013

Barbara McBeth, AICP
Deputy Director of Community Development
City of Novi
45175 W. Ten Mile Rd.
Novi, MI 48375



**SUBJECT: GFS Marketplace, JSP12-0071,
Traffic Review of Preliminary Site Plan (PSP12-0059)**

Dear Ms. McBeth:

At your request, we have reviewed the above and offer the following recommendation and supporting comments.

Recommendation

We recommend approval of the preliminary site plan, subject to the items shown below in **bold** being satisfactorily addressed on the final site plan.

Project Description

What is the applicant proposing?

1. The applicant, Gordon Food Service, is proposing to construct a 16,295-s.f. store on a 2.15-acre parcel to be split off from the Twelve Mile Crossing at Fountain Walk shopping center. The subject parcel is on the southwest corner of Twelve Mile Road and Donelson Drive. All vehicular access would occur via the existing Fountain Walk parking lot, through which the necessary cross-access easements must be negotiated and duly recorded.

Trip Generation

How much traffic would the proposed development generate?

2. The Institute of Transportation Engineers appears to have no trip generation data for this type of store. The Planning Commission may wish to have the applicant comment on typical daily and peak-hour trip generation by its stores.

Vehicular Access Locations

Do the proposed driveway locations meet City spacing standards?

3. Not applicable. As noted above, all vehicular access would occur via the existing shopping center parking lot and associated access drives.

Vehicular Access Improvements

Will there be any improvements to the abutting road(s) at the proposed driveway(s)?

4. Not applicable.

Driveway Design and Control

Are the driveways acceptably designed and signed?

5. Not applicable.

Pedestrian Access

Are pedestrians safely and reasonably accommodated?

6. In response to our pre-application comments, a sidewalk connection is now proposed to the Twelve Mile safety path at Donnelson. We had also recommended that a "suitable sidewalk connection" be provided to "the shopping center's main north building pad," but none has been proposed. The Planning Commission may wish to have the applicant address this issue.

Parking and Circulation

Are parking spaces appropriately designed, marked, and signed? Can vehicles safely and conveniently maneuver through the site?

7. A note on sheet C-102 states that "all dimensions shown to concrete curb and gutter are to back of curb unless otherwise noted." **This note should be expanded, or supplemented by another note, to indicate that "all parking space dimensions (width as well as length) are referenced to face of curb or walk."**
8. We were unable to complete our normally comprehensive review due to the plan set lacking a Paving and Grading sheet showing the elevations of curbs, sidewalks, etc. **No later than the final site plan, a Paving and Grading sheet must be included (possibly earlier, depending on the wishes of the City Engineering reviewer).**
9. As requested, the sidewalk around the building has been widened to 7 ft; however, the adjacent parking spaces have been shortened only to 18 ft rather than the 17 ft requested; **the applicant should explain the need for the 1 ft of extra pavement (rather than landscaping behind the sidewalk).** Also, any space length less than 19 ft requires the sidewalk height to be limited to 4 inches (per Sec 2509.3.c(2)(c) of the Zoning Ordinance). Although we are unable to find any relevant elevation data in the plans, **it appears from a note on sheet C-103 ("Slope sidewalk down 6" so flush with bituminous pavement at striped aisle") that the sidewalk height is now proposed to be an unacceptable 6 inches.**
10. **The barrier-free sidewalk ramps, parking space markings, and signage need to be detailed consistent with ADA requirements and the specifications we provided with our pre-application comments (another copy attached to current letter).** Required items include:
 - a. **Sidewalk ramps shown and/or noted as having a preferred slope of 5%.**

- b. **Striping color of blue (not yellow per the current plan note), with adjacent barrier-free and non-barrier-free spaces separated by abutting blue and white stripes.**
 - c. **Wheelchair symbols painted on the pavement in white (not blue), facing to the right when viewed from the parking aisle (not the left).**
 - d. **Two signs on each of the four posts, RESERVED PARKING [wheelchair symbol facing right] ONLY (R7-8) above VAN ACCESSIBLE (R7-8P), with a minimum of 6'-8" below the latter sign.**
11. **The plan note specifying various barrier-free parking features also needs to be revised to remove an obsolete reference to a "precast bumper block" (which will not be used) as well as inaccurate references to "a sign" (rather than two for each space) and the "Manual of Uniform Traffic Controls" (an incorrect title).**
12. **The proposed no parking zone immediately south of the main building entrance lacks a striping specification as well as any signage. A NO PARKING ANY TIME sign (R7-1 but with no arrow below) should be mounted on the building façade to the right of the window (see west elevation on sheet A-201). The crosshatching specification for this zone should match the one used at the northwest corner of the building pad (4-inch yellow, 4 ft on-center). With the installation of the requested sign, the words "NO PARKING" apparently intended as a pavement marking are optional.**

Sincerely,
BIRCHLER ARROYO ASSOCIATES, INC.



Rodney L. Arroyo, AICP
Vice President

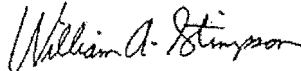

William A. Stimpson, P.E.
Director of Traffic Engineering

Attachments:

Aerial photo
Typical details for alternative treatment of barrier-free parking ramps



Site of Proposed Gordon Food Service (at Twelve Mile Crossing at Fountain Walk)

Alternative A: Flat Parking Surface with Sidewalk Ramped - Wheel Stops Not Required

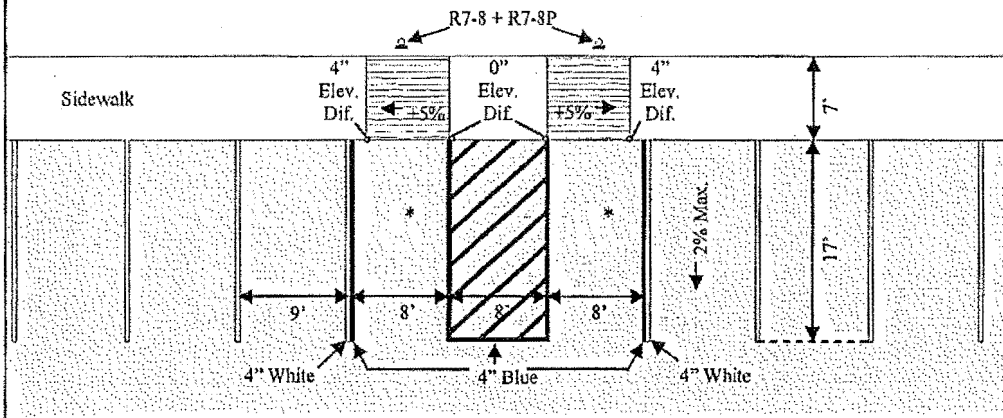

*White, per MMUTCD Fig. 3B-22

Alternative B: Flat Parking Surface with Sidewalk Ramps - Wheel Stops Required

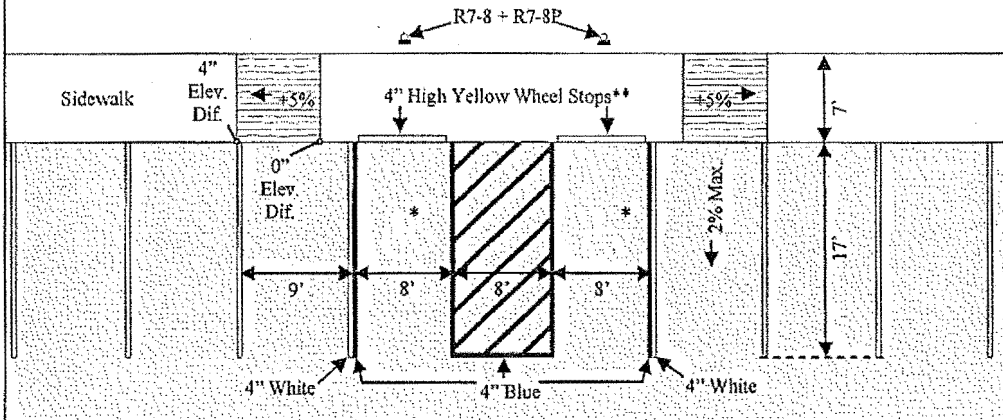

*White, per MMUTCD Fig. 3B-22 ** Parking face 17' from parking aisle

Alternative C: Sloped Parking Surface with Flat Sidewalk

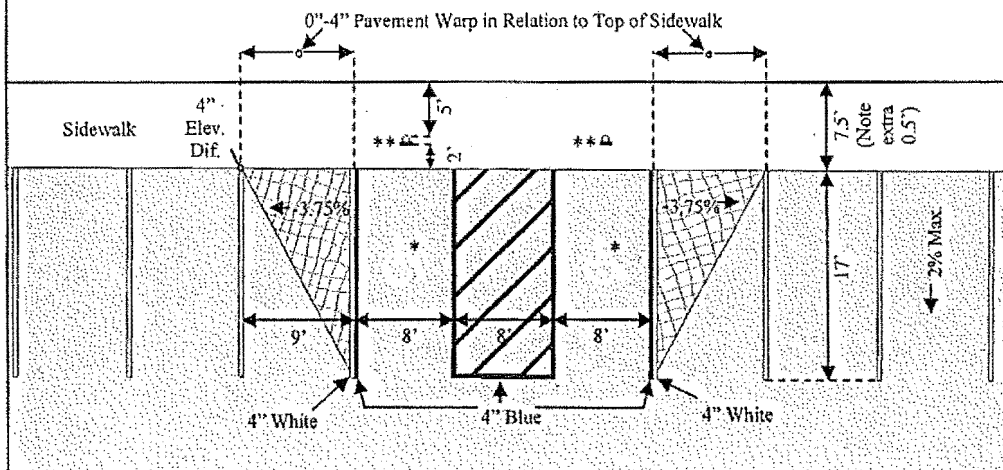

*White, per MMUTCD Fig. 3B-22 ** Standard signs with 6" diameter base pipes (If signs are located behind walk, wheel stops are needed.)

LANDSCAPE REVIEW

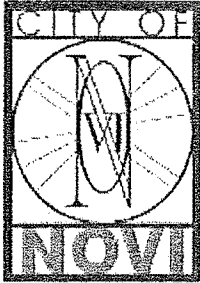

cityofnovi.org

PLAN REVIEW CENTER REPORT

December 26, 2012

Preliminary Site Plan

GFS Marketplace

Property Characteristics

- Site Location: 12 Mile / Donelson Drive
- Site Zoning: RC – Regional Center
- Plan Date: 12/14/12

Recommendation

Approval of the Preliminary Site Plan for GFS Marketplace JSP#12-59 is recommended provided the Applicant receives the necessary waivers from the Planning Commission. Please address the concerns noted below upon subsequent submittal.

Ordinance Considerations

Adjacent to Public Rights-of-Way – Berm (Wall) & Buffer (Sec. 2509.3.b.)

1. A 3' tall berm is required along the right-of-ways adjacent to parking areas. The existing berm and slope will remain, thereby preserving the existing mature vegetation.
2. Right-of-way greenbelt planting calculations have been provided and requirements have been met. Existing mature vegetation will be preserved.

Street Tree Requirements (Sec. 2509.3.b.)

1. One street tree is required per 45 LF adjacent to parking; one street tree is required per 55 LF where there is no parking. This requirement has been met.

Parking Landscape (Sec. 2509.3.c.)

1. A total of 2,359 SF of interior parking landscape area is required. This requirement has been met.
2. A total of 19 Parking Lot Canopy Trees are required. This requirement has been met.
3. The Applicant is proposing 16 parking spaces along the west property line. The ordinance requires an interior parking lot island for any bank of parking numbering greater than fifteen (15). **Staff would not support the waiver. A landscape island should be added.**

Parking Lot Perimeter Canopy Trees (Sec. 2509.3.c.(3))

1. Perimeter Parking Lot Canopy Trees are required per 35 LF surrounding parking and access areas. The requirement has been met.

Building Foundation Landscape (Sec. 2509.3.d.)

1. A minimum 4' wide landscape bed is required around the entire building foundation with the exception of access areas. The Applicant should add

landscape plantings on the east and north side of the building in order to meet the intent of the ordinance.

2. A total of 4,280 SF of building foundation landscape area is required. The Applicant has requested a variance for providing a majority of the foundation landscape along the east side of the building, but would need to provide more plantings in this area. With the addition of plantings on the east and north side of the building, the Applicant would meet the intent of the ordinance. **Staff would support the waiver if additional plantings are provided.**

Plant List (LDM)

1. Please provide the required Plant list per the requirements of the Ordinance and Landscape Design Manual. **Standard cost figures per the City of Novi must be used in calculating the total costs and should be shown on the plans.**

Planting Notations and Details (LDM)

1. Planting notations and details have been provided per the Ordinance and Landscape Design Manual.

Irrigation (Sec. 2509 3.f.(6)(b))

1. An Irrigation Plan must be provided upon Stamping Set submittal.

Please follow guidelines of the Zoning Ordinance and Landscape Design Guidelines. This review is a summary and not intended to substitute for any Ordinance. For the landscape requirements, see the Zoning Ordinance landscape section on 2509, Landscape Design Manual and the appropriate items in the applicable zoning classification.



Reviewed by: David R. Beschke, RLA

FACADE REVIEW



Phone: (248) 880-6323
 E-Mail: dnecci@drnarchitects.com
 Web: drnarchitects.com



DRN & ASSOCIATES, ARCHITECTS, PC

50850 Applebrooke Dr., Northville, MI 48167

January 15, 2013

City of Novi Planning Department
 45175 W. 10 Mile Rd.
 Novi, MI 48375-3024

Re: **FACADE ORDINANCE - Façade Review – Preliminary & Final S.P.**
Gordon Food Service, PSP12-0059
 Façade Region: 1, Zoning District: RC-1

Dear Ms. McBeth;

The following is the Façade Review for Preliminary and Final Site Plan Approval of the above referenced project based on the drawings prepared by Paradigm Design, dated 12/18/12. The percentages of materials proposed for each façade are as shown on the table below. The maximum percentages allowed by the Schedule Regulating Façade Materials (AKA Façade Chart) of Ordinance Section 2520 are shown in the right hand column. Materials in non-compliance with the Façade Chart, if any, are highlighted in bold.

	Noth (Front)	South	West	East	Ordinance Maximum (Minimum)
Brick (natural clay)	0.0%	0.0%	0.0%	0.0%	100% (30%)
C-Brick (Bella Brick, GFS Blend)	64.5%	73.0%	70.0%	71.5%	25.0%
EIFS	8.0%	7.0%	7.0%	7.5%	25%
Cast Stone (sills)	1.5%	2.0%	2.0%	1.5%	25%
Split Faced C.M.U.	16.0%	15.0%	15.0%	16.5%	10%
Flat Metal (coping)	3.0%	3.0%	3.0%	3.0%	50%

As shown above the percentages of Split Faced C.M.U. and C-Brick exceed the maximum percentage allowed by the Façade Ordinance and the percentage of Natural Clay Brick is below the minimum percentage required by the Façade Ordinance. The sample board provided by the applicant indicates that the proposed C-Brick exhibits a natural red color with a range of tones between individual units that will be consistent with natural clay brick. The Split Faced C.M.U. is used as a base capped by a stone sill that enhances the overall design. All colors have been carefully selected and are consistent with buildings in the surrounding area.

It is noted that the east façade consists of large expanses of the Brick and Split Faced C.M.U. with less articulation than the other façades. In consideration of the fact that this façade will be highly visible from Donaldson Drive, additional articulation of this facade is strongly recommended. This could be accomplished, for example by incorporating projecting pilasters with accompanying projecting cornices located approximately at the control joint locations along with false windows or variations in brick coursing. It is recommended that similar articulation be added to the west façade for the sake of consistency.

Recommendation - It is our recommendation that the design is consistent with the intent and purpose of the Façade Ordinance and that a Section 9 Waiver be granted for the underage of Brick and the overage of C-Brick and Split Faced Concrete Masonry Units (C.M.U.). This recommendation is contingent upon the applicant submitting revised drawings showing additional articulation of the east and west façades consistent with the above comments.

Notes to the Applicant:

1. A dumpster enclosure is indicated on the Site Plan however no detail is provided. It should be noted that the Façade Ordinance requires the dumpster enclosure to be constructed of materials that match the primary building (C-Brick).
2. The Façade Ordinance requires inspection(s) for all projects. Materials and colors displayed on the approved sample board will be compared to materials delivered to the site. It is the applicant's responsibility to request the inspection of each façade material and paint color at the appropriate time, before installation on the building. Please use the Novi Building Department's Online Inspection Portal by following the link below. Please click on "Click here to Request an Inspection" under "Contractors", then click "Façade". Inspections will be performed by the end of the following business day. .

<http://www.cityofnovi.org/Services/CommDev/OnlineInspectionPortal.asp>

If you have any questions regarding this project please do not hesitate to call.

Sincerely,
DRN & Architects PC

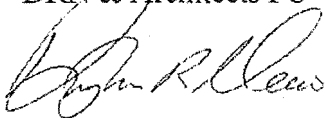

Douglas R. Necci, AIA

FIRE REVIEW

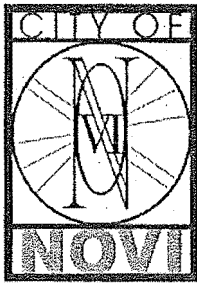

November 20, 2012

January 3, 2013 - REVISED

TO: Barbara McBeth, Deputy Director of Community Development
Joseph Shelton, Fire Marshal

RE: GFS Marketplace (New Retail) – Preliminary Site Plan

JSP#: 12-0071
PSP12-0045
PSP12-0059

CITY COUNCIL

Mayor
Bob Gatt

Mayor Pro Tem
Dave Staudt

Terry K. Margolis

Andrew Mutch

Justin Fischer

Wayne Wrobel

Laura Marie Casey

City Manager
Clay J. Pearson

Director of Public Safety
Chief of Police
David E. Molloy

Director of EMS/Fire Operations
Jeffery R. Johnson

Assistant Chief of Police
Victor C.M. Lauria

Assistant Chief of Police
Jerrod S. Hart

Project Description:

New retail location and building of approx. 15, 857 Sq/Ft on empty lot of 2.15 acres at the Fountain Walk Mall site property (12 Mile Rd x Donelson Dr).

Comments:

Requirement met - 1/3/13 - noted by Contractor on final site plan -
Only one fire hydrant is shown on site plan. Per City of Novi Ordinance – section 912.2.3, building FDC must be located within 100 ft of hydrant. If field changes are made to the sprinkler system, note that FDC location must be within this distance to this hydrant.

Recommendation:

Second review has been completed and is recommended for **APPROVAL.**

Sincerely,

Andrew Copeland – Inspector II/CFPE
City of Novi – Fire Dept.

cc: file

Novi Public Safety Administration
45125 W. Ten Mile Road
Novi, Michigan 48375
248.348.7100
248.347.0590 fax

cityofnovi.org

APPLICANT RESPONSE LETTER



paradigm
design inc.

Architects • Civil Engineers

February 4, 2013

City Planning Commission
45175 W Ten Mile Road
Novi, MI 48375

Re: GFS Marketplace Store
Preliminary Plan Review Response (JSP-12-71)
Paradigm Project #1205049

Dear Planning Commissioners:

We are in receipt of a plan review report dated January 16, 2013 for the above project. This letter summarizes plan review comments from various departments. A large majority of the comments address items to be revised for future submittals, and these comments have been noted and we will comply at the time of future final site plan submittal. In response to the remaining questions/comments we have prepared the following:

Waiver Requests:

- ***We are formally requesting a waiver from the requirement to submit a Community Impact Statement, based on the relatively small project size compared to the overall existing Fountain Walk development***
- ***We are formally requesting a waiver from the requirement to submit a Traffic Impact Study, based again on the relatively small project size compared to the overall existing Fountain Walk development. In addition, previous traffic studies have been submitted and approved for the larger development, and these studies should still be considered valid even with the addition of the Gordon Food Service.***

Planning Review (will comply with all comments with additional input as follows):

- We have submitted for the various variance requests noted in the staff report, and expect to receive these approvals at the March ZBA meeting.
- Parking spaces located adjacent to the building will be revised to provide a 4" tall curb, and these spaces will also be shortened to 17' long (currently shown as 18' long).
- Dumpster screening will be provided on three sides (north, east and south) with a 6' tall masonry wall matching the building materials. A wood gate on the west side will complete the dumpster enclosure.
- Subsequent site lighting plans will include the average to minimum ration to demonstrate compliance with 4:1 maximum per zoning ordinance

Engineering Review (will comply with all comments, with additional input as follows):

- 3.) We have made the current land owner (Sun Valley Ltd.) aware of the need for Fountain Walk warranty deed, and will supply this prior to Final Site Plan submittal.
- 12 & 13.) The drainage ditch east of the building will be revised to slope at 2%, which will require a yard basin southeast of GFS building that will connect to an existing storm manhole in Donelson Street driveway.

16-18.) A Reciprocal Easement Agreement (REA) will be created between GFS and Sun Valley Ltd. (current Fountain Walk development owner) to address defined access easements, common driveways, storm water drainage and utilities). This will be provided to City prior to final site plan approval.

Traffic Review (will comply with all comments, with additional input as follows):

- 1.) We are working through the Reciprocal Easement Agreement (REA) document that will address cross-access and shared driveway areas. This document will be recorded at the time of closing on the property, and a copy provided to City at that time.
- 2.) Based on past project experience, a typical GFS store will provide trip generation most closely approximated by ITE Land Use 820 (Shopping Center). This is based on a comparison of GFS transaction data at various stores over a 1-year period. Using this land use code, approximately 700 daily trips are generated at the store, with a peak PM hour of 60 trips (30 inbound and 30 outbound).
- 6.) The preliminary site plan has contemplated a sidewalk connection to existing retail buildings southwest of the GFS property. However, due to grade concerns we are not showing this connection.
- 9.) Parking spaces adjacent to the building were reduced to 18' (from 20' on Concept Plan), and will be further reduced to 17' at the time of final site plan submittal. At that time, the sidewalk height will be clarified as 4" tall (not 6" as noted).
- 10.) Barrier free parking spaces will be further revised in accordance with both ADA and City requirements, as noted in comments a – d.
- 11.) Any reference to precast concrete bumper blocks will be eliminated (they are no longer proposed as part of this project).
- 12.) A "No Parking Any Time" sign will be added to the north side of the west elevation of the building as noted.

Landscape Review (will comply with all comments, with additional input as follows):

Parking-3.) The site plan as well as the landscape plan will be revised to show a wider landscape plan along west row of parking in order to reduce number of consecutive spaces to 15 (waiver request withdrawn)

Bldg Foundation-2.) Additional plantings will be added east of the proposed GFS building to offset requested waiver for foundation landscape area.

Plant List-1.) Standard cost figures will be incorporated into subsequent landscape plan submittals, and be shown on the plan.

Facade Review (will comply with all comments, with additional input as follows):

- 1.) The dumpster enclosure materials will match the building façade (C-brick) and this will be shown on plans as part of final site plan submittal

Fire Review (will comply with all comments, with additional input as follows):

- The Fire Department Connection as shown on preliminary site plan is located within 100' of the relocated hydrant and complies with City ordinance.

Page 3 of 3
February 4, 2013
GFS Marketplace – Novi
Preliminary Plan Review Response (JSP-12-71)
Paradigm Project #1205049

I trust that our responses adequately address your concerns. Should you have any further questions, or require any additional information to complete your review, please do not hesitate to contact me at (616)785-5567 or jwalsh@paradigmae.com.

Sincerely,

PARADIGM DESIGN, INC.



John Walsh, P.E., LEED® AP
Associate

Cc: Ryan Systema - GFS
Jack Watkins - Paradigm Design, Inc.
File

SECTION 15
T-1-N., R-8-E.,
CITY OF NOVI
OAKLAND COUNTY

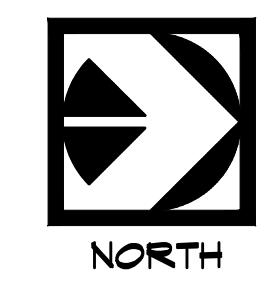

CABARET DRIVE

N 87°32'34"E
35.00'

N 7°52'22" W
27.00'

5 42°38'24" W
38.25'

N 87°32'34" E
202.19'

N 87°32'34" E
264.00'

N 87°32'34" E
989.28'

N 87°32'34" E
679.54'

N 87°32'34" E
962.00'

N 87°32'34" E
1585.74'

N 87°32'34" E
1797.40'

N 87°32'34" E
11600.00'

N 87°32'34" E
15857.00'

N 87°32'34" E
15857.00'

N 87°32'34" E
15857.00'

N 87°32'34" E
15857.00'

N 87°32'34" E
15857.00'

N 87°32'34" E
15857.00'

N 87°32'34" E
15857.00'

N 87°32'34" E
15857.00'

N 87°32'34" E
15857.00'

N 87°32'34" E
15857.00'

N 87°32'34" E
15857.00'

N 87°32'34" E
15857.00'

N 87°32'34" E
15857.00'

N 87°32'34" E
15857.00'

N 87°32'34" E
15857.00'

N 87°32'34" E
15857.00'

N 87°32'34" E
15857.00'

N 87°32'34" E
15857.00'

NORTH CORNER
SECTION 15
POINT OF BEGINNING
EXCEPTED RIGHT OF WAY

TWELVE MILE ROAD

Retail

Sears Outlet	156,236
American Home Fitness	11,600
Dick's Sporting Goods	41,700
Family of Pets	1,538
Existing Vacant Retail	102,067
Proposed Retail	50,046
Proposed Gordon Food Service	15,857
Subtotal =	379,044

Restaurants

Bar Louie	11146
Buffalo Wild Wings	6766
Cold Stone Creamery	1505
Codaiko Japanese Restaurant	7303
Hooters	4200
Indo Fusion	4533
Rojo Mexican Bistro	6514
Mymt Martini w/Outdoor Seating	6269
Tilted Kilt w/Outdoor Seating	8000
Proposed w/Outdoor Seating	7568
Subtotal =	63,804

Entertainment

M-Bar-Go	60,704
Lucky Strike w/Outdoor Seating	
Liquor Store	
Chuck E. Cheese's	15535
Imagine Novi Theatre	72255
Gjeto's Salon & Day Spa	2914
Powerhouse Gym	58950
Putting Edge Fun Centers	9516
Subtotal =	219874

42% > 20%

NORTHEAST CORNER
SECTION 15
T-1-N., R-8-E.,
CITY OF NOVI
OAKLAND COUNTY

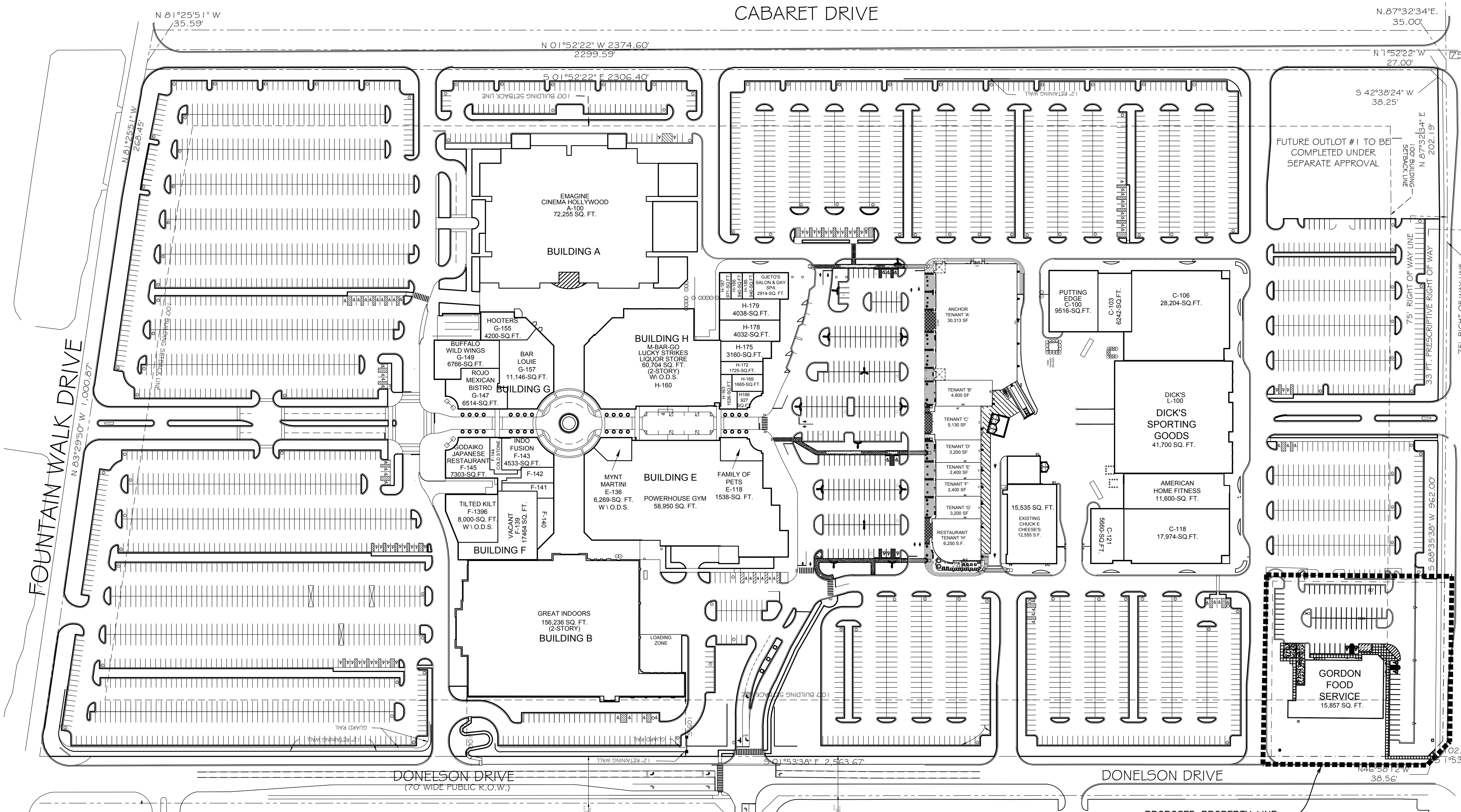

SITE DATA

EXISTING ZONING	RC
GROSS SITE AREA	67.21 ACRES
EXISTING WETLANDS	NONE
EXISTING WOODLANDS	NONE
EXISTING BUILDING AREA	579,256 SQ. FT.
PROPOSED BUILDING AREA	57,493 SQ. FT.
MAXIMUM HEIGHT OF BUILDING	45 FEET
EXISTING PAVEMENT AREA	
PROPOSED PAVEMENT AREA	±68,132 SQ. FT.
BUILDING SETBACKS	REQUIRED PROVIDED
NORTH SETBACK	100' ±378'
WEST SETBACK PROP. LINE	100' ±100'
EAST SETBACK PROP. LINE	100' ±134'
SOUTH SETBACK PROP. LINE	100' ±584'
PARKING SETBACKS	REQUIRED PROVIDED
NORTH SETBACK	20' ±38'
WEST SETBACK PROP. LINE	10' ±20'
EAST SETBACK PROP. LINE	20' ±20'
SOUTH SETBACK PROP. LINE	20' ±30'

REQUIRED PARKING	
THEATER:	
1 SPACE PER 3.4 SEATS PLUS 1 SPACE PER EVERY 2 EMPLOYEES	
3377 SEATS/3.4 SEATS + 30 EMPLOYEES/2 = 1008 SPACES	
RESTURANTS:	
1 SPACE PER 70-SFT G.F.A.	
63804-SFT/70-SFT = 912 SPACES	
INCLUDING OUTDOOR SEATING	
RETAIL:	
1 SPACE PER 250-SFT G.F.A.	
510806-SFT/250-SFT = 2043 SPACES	
TOTAL = 3963-SPACES	
PROVIDED PARKING	
HANDI CAP SPACES	72
STANDARD SPACES	4005
TOTAL SPACES	4077-SPACES

* GFS TO PROVIDE PARKING ON SEPARATE LOT
(NOT INCLUDE IN OVERALL PARKING CALCULATIONS)

LEGAL DESCRIPTION:
T1N, R8E, SECTION 15 PART OF NW 1/4 & PART OF NE 1/4 ALL DESCRIBED AS BEGINNING AT A POINT DISTANCE S 88-35-38 W 1690.26 FEET FROM NORTHEAST CORNER OF SECTION 15, THENCE S 01-53-38 E 2563.67 FEET, THENCE N 83-29-50 W 1000.87 FEET, THENCE N 81-25-51 W 268.45 FEET, THENCE N 01-52-22 W 2374.60 FEET, THENCE N 87-32-34 E 264.01 FEET, THENCE N 88-35-38 E 989.28 FEET TO THE POINT OF BEGINNING EXCEPT BEGINNING AT A POINT DISTANCE S 88-35-38 W 2679.54 FEET & S 87-32-34 W 229.01 FEET & S 01-52-22 E 75 FEET FROM NE SECTION CORNER, THENCE S 01-52-22 E 2306.40 FEET, THENCE N 81-25-51 W 35.59 FEET, THENCE N 01-52-22 W 2299.59 FEET, THENCE N 87-32-34 E 35 FEET TO THE POINT OF BEGINNING, ALSO EXCEPT BEGINNING AT N 1/4 CORNER, THENCE N 88-35-38 E 989.28 FEET, THENCE S 01-53-38 E 102 FEET, THENCE N 46-58-12 W 38.57 FEET, THENCE S 88-35-38 W 962 FEET, THENCE S 87-32-34 W 202.19 FEET, THENCE S 42-38-24 W 38.25 FEET, THENCE N 01-52-22 W 27 FEET, THENCE S 87-32-34 W 35 FEET, THENCE N 01-52-22 W 75 FEET, THENCE N 87-32-34 E 264.01 FEET, TO THE POINT OF BEGINNING 67.21 A5-12-00 FR 001 TO 004, 072, 079,084 TO 087,126-011&013 1-14-02 CORR

ARCHITECTS • CIVIL ENGINEERS

paradigm design

550 3 MILE N.W.
SUITE B
GRAND RAPIDS, MI 49544

PHONE (616) 785 - 5656
FAX (616) 785 - 5657
WEB PARADIGMAE.COM

STATE OF MICHIGAN
JOHN R. WALSH
ENGINEER
12/1/12

PROJECT

GFS MARKETPLACE

NOVI
LOCATED IN SECTION 15
APPROX. 44225 W. 12 MILE RD
NOVI, MICHIGAN

DEVELOPER:

GFS MARKETPLACE REALTY FIVE, LLC

P.O. BOX 1812
GRAND RAPIDS, MICHIGAN

RELEASE DATE

11-9-12 PRE-APPLICATION MEETING
12-14-12 PRELIMINARY SITE PLAN REVIEW

PROJECT

1205049

SHEET

G-100

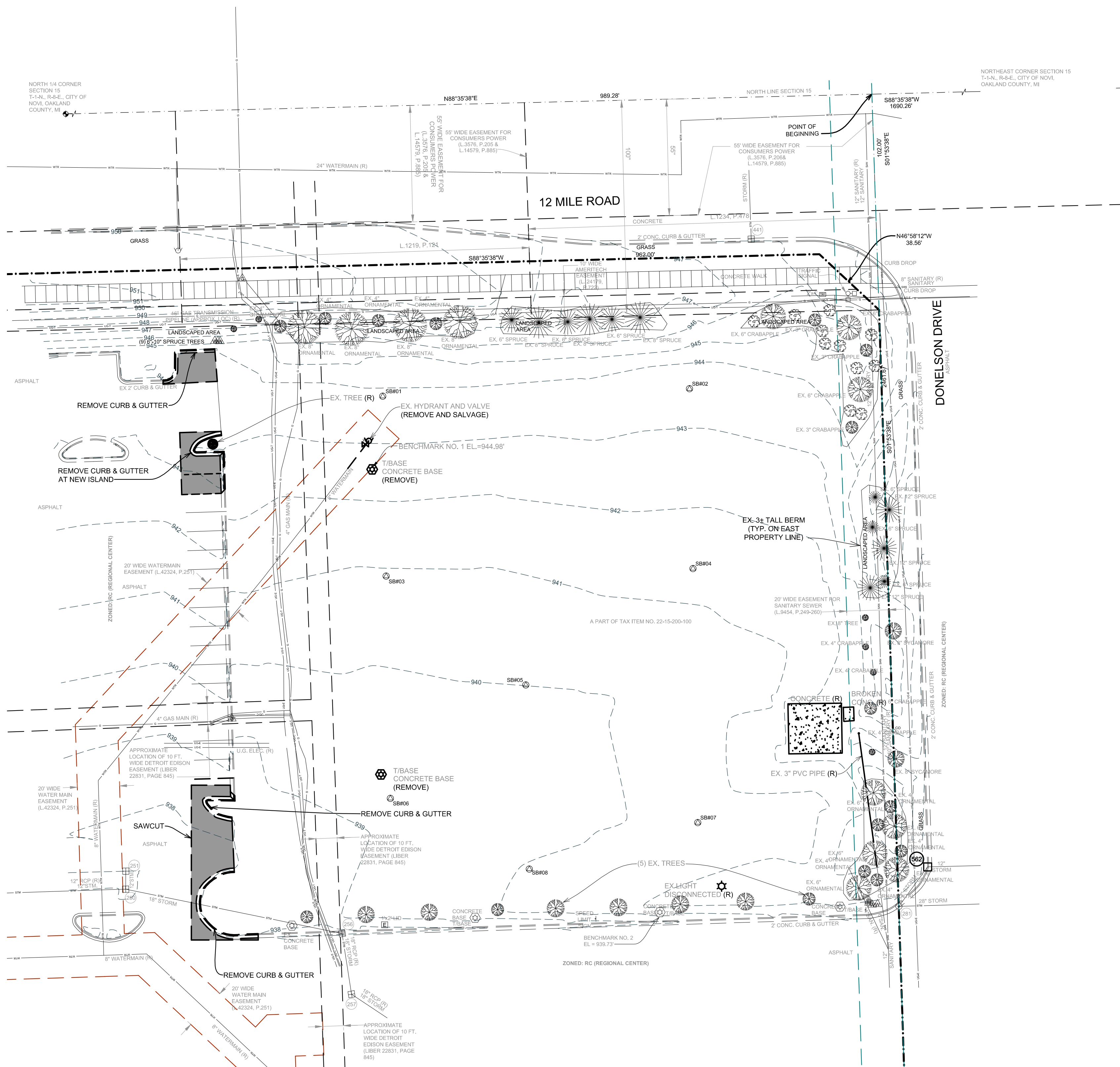

EXISTING STRUCTURE TABLE

CB-250 RIM: 936.87 12" (N) INV: 930.67 12" (W) INV: 929.43 18" (SE) INV: 929.07	ST-281 RIM: 940.24 12" (NE) INV: 935.04 28" (E) INV: 932.59
CB-251 RIM: 936.87 12" (S) INV: 931.17	CB-441 RIM: 945.68 S-494 RIM: 945.35 12" (N & S) INV: 929.05
CB-256 RIM: 937.30 18" (NW) INV: 928.10 18" (S) INV: 928.10	CB-561 RIM: 939.98 CB-562 RIM: 940.57 12" (SW & E) INV: 940.57
S-280 RIM: 940.07 12" (N & S) INV: 927.92	

BENCHMARK DATA
(N.G.V.D. 1929) DATUM

SITE BENCHMARK NO. 1
SOUTHWESTERLY TOP OF CONCRETE LIGHT POLE
BASE APPROXIMATELY 270 FEET WEST OF DONELSON
DRIVE AND APPROXIMATELY 170 FEET SOUTH OF
12 MILE ROAD.
ELEVATION=944.98'

SITE BENCHMARK NO. 2
SOUTH TOP OF CONCRETE LIGHT POLE BASE,
APPROXIMATELY 150 FEET WEST OF DONELSON DRIVE
AND APPROXIMATELY 380 FEET SOUTH OF
12 MILE ROAD.
ELEVATION=939.73'

PROPERTY DESCRIPTION (OVERALL DEVELOPMENT PARCEL)

(PER TITLE COMMITMENT NO. 602591, PREPARED BY FIRST AMERICAN TITLE INSURANCE COMPANY,
DATED SEPTEMBER 07, 2012.)

THE LAND REFERRED TO IN THIS COMMITMENT, SITUATED IN THE COUNTY OF OAKLAND, CITY OF NOVI,
STATE OF MICHIGAN, IS DESCRIBED AS FOLLOWS:

PART OF THE NORTHWEST 1/4 AND THE NORTHEAST 1/4 OF SECTION 15, TOWN 1 NORTH, RANGE 8
EAST, CITY OF NOVI, OAKLAND COUNTY, MICHIGAN, DESCRIBED AS: COMMENCING AT THE NORTHEAST
CORNER OF SECTION 15, AND PROCEEDING THENCE SOUTH 88 DEGREES 35 MINUTES 38 SECONDS
WEST, 1,690.28 FEET ALONG THE NORTH LINE OF SAID SECTION 15 TO THE POINT OF BEGINNING;
THENCE SOUTH 01 DEGREES 53 MINUTES 38 SECONDS EAST, 2,563.67 FEET ALONG THE WEST LINE OF
DONELSON DRIVE (70.00 FEET WIDE); THENCE NORTH 83 DEGREES 29 MINUTES 50 SECONDS WEST,
1,000.87 FEET TO A POINT ON THE NORTH-SOUTH 1/4 LINE OF SAID SECTION 15, THENCE NORTH 81
DEGREES 25 MINUTES 51 SECONDS WEST, 268.45 FEET; THENCE NORTH 01 DEGREES 52 MINUTES 22
SECONDS WEST, 2,374.60 FEET TO A POINT ON THE NORTH LINE OF SAID SECTION 15, THENCE NORTH
87 DEGREES 32 MINUTES 34 SECONDS EAST, 264.01 FEET ALONG SAID NORTH LINE TO THE NORTH 1/4
CORNER OF THE SAID SECTION 15, THENCE CONTINUING ALONG SAID NORTH LINE, NORTH 88
DEGREES 35 MINUTES 38 SECONDS EAST, 989.28 FEET TO THE POINT OF BEGINNING.

EXCEPT A PART OF THE NORTHWEST 1/4 OF SECTION 15, TOWN 1 NORTH, RANGE 8 EAST, CITY OF
NOVI, OAKLAND COUNTY, MICHIGAN, DESCRIBED AS: BEGINNING AT THE NORTHWEST CORNER OF
SECTION 15 AND PROCEEDING SOUTH 88 DEGREES 35 MINUTES 38 SECONDS WEST, 2,679.54 FEET
ALONG THE NORTH LINE OF SAID SECTION 15 TO THE NORTH 1/4 CORNER OF SECTION 15, THENCE
CONTINUING SOUTH 87 DEGREES 32 MINUTES 34 SECONDS WEST, 229.01 FEET ALONG THE SAID
NORTH LINE, THENCE SOUTH 01 DEGREES 52 MINUTES 22 SECONDS EAST, 75.00 FEET TO A POINT OF
BEGINNING; THENCE SOUTH 01 DEGREES 52 MINUTES 22 SECONDS EAST, 2,308.40 FEET; THENCE
NORTH 81 DEGREES 25 MINUTES 51 SECONDS WEST, 35.59 FEET; THENCE NORTH 01 DEGREES 52
MINUTES 22 SECONDS WEST, 2,299.59 FEET; THENCE NORTH 87 DEGREES 32 MINUTES 34 SECONDS
EAST, 35.00 FEET TO THE POINT OF BEGINNING, AS CONVEYED TO THE CITY OF NOVI, AS DISCLOSED BY
WARRANTY DEED RECORDED IN LIBER 22604, PAGE 499, OAKLAND COUNTY RECORDS;

ALSO EXCEPT A PART OF THE NORTHWEST 1/4 OF SECTION 15, TOWN 1 NORTH, RANGE 8 EAST, CITY OF
NOVI, OAKLAND COUNTY, MICHIGAN, DESCRIBED AS: BEGINNING AT THE NORTH 1/4 CORNER OF
SECTION 15; THENCE NORTH 88 DEGREES 35 MINUTES 38 SECONDS EAST, 989.28 FEET ALONG THE
NORTH LINE OF SECTION 15; THENCE SOUTH 01 DEGREES 53 MINUTES 38 SECONDS EAST, 102.00 FEET;
THENCE NORTH 46 DEGREES 58 MINUTES 12 SECONDS WEST, 38.57 FEET; THENCE SOUTH 88 DEGREES
35 MINUTES 38 SECONDS WEST, 862.00 FEET TO A POINT ON THE NORTH-SOUTH 1/4 LINE OF SAID
SECTION 15; THENCE SOUTH 87 DEGREES 32 MINUTES 34 SECONDS WEST, 202.19 FEET; THENCE
SOUTH 42 DEGREES 38 MINUTES 24 SECONDS WEST, 38.25 FEET; THENCE NORTH 01 DEGREES 52
MINUTES 22 SECONDS WEST, 27.00 FEET; THENCE SOUTH 87 DEGREES 32 MINUTES 34 SECONDS
WEST, 35.00 FEET; THENCE NORTH 01 DEGREES 52 MINUTES 22 SECONDS WEST, 75.00 FEET TO A
POINT ON THE NORTH LINE OF SAID SECTION 15; THENCE NORTH 87 DEGREES 32 MINUTES 34
SECONDS EAST, 264.01 FEET ALONG THE NORTH LINE OF SAID SECTION 15 TO THE POINT OF
BEGINNING, AS CONVEYED TO THE CITY OF NOVI, AS DISCLOSED BY WARRANTY DEED RECORDED IN
LIBER 22757, PAGE 605, OAKLAND COUNTY RECORDS.

TAX ITEM NO. 22-15-200-100

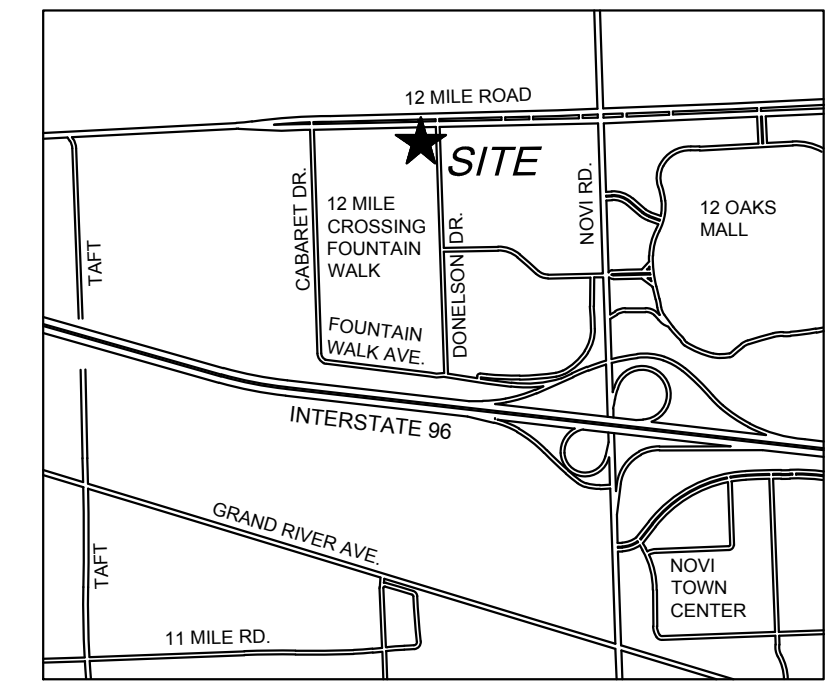

LOCATION MAP
(NOT TO SCALE)

DEMOLITION NOTES:

GENERAL: REFERENCE SECTION 02 4116-STRUCTURE DEMOLITION, SECTION 31 1000-SITE
CLEARING AND SECTION 31 2000-EARTHWORK OF SPECIFICATION BOOK.

ALL AREAS OF UNDERGROUND DEMOLITION; UTILITY LINE REMOVAL; AND UNDERGROUND
TREE, STUMP, AND VEGETATION REMOVAL SHALL BE BACKFILLED.

BACKFILLING SHALL PROMPTLY FOLLOW UNDERGROUND DEMOLITION OR REMOVAL WORK
AND SHALL CONTINUE AS THE DEMOLITION PROGRESSES.

NOTIFY ARCHITECT/ENGINEER OF ANY OTHER UNDERGROUND MATERIALS OR EQUIPMENT
ENCOUNTERED DURING EXCAVATION NOT SPECIFICALLY NOTED ON THE DRAWING(S).

PRIVATE UTILITY REMOVAL - CONTRACTOR TO COORDINATE PRIVATE UTILITY (GAS, ELECTRIC,
PHONE, CABLE, ETC.) REMOVAL WITH APPROPRIATE AUTHORITY. ALTHOUGH ALL PRIVATE
UTILITY SERVICES MAY NOT BE SHOWN ON THIS DRAWING, CONTRACTOR IS RESPONSIBLE FOR
REMOVAL OF SERVICE TO RIGHT-OF-WAY LINE.

PUBLIC UTILITY REMOVAL - CONTRACTOR TO COORDINATE PUBLIC UTILITY (WATER, SEWER,
STORM) REMOVAL WITH APPROPRIATE UTILITY COMPANY. ALTHOUGH ALL PUBLIC UTILITY
SERVICES MAY NOT BE SHOWN ON THIS DRAWING, CONTRACTOR IS RESPONSIBLE FOR
REMOVAL OF SERVICE TO RIGHT-OF-WAY LINE.

WHERE CURBING OR PAVEMENT IS INDICATED TO BE REMOVED, IT SHALL BE SAWCUT FULL
DEPTH, REMOVE TO THE NEAREST JOINT, IF THE JOINT IS WITHIN
3 FEET OF THE REMOVAL LINE. VERIFY REMOVAL LIMITS WITH ENGINEER PRIOR
TO BEGINNING WORK.

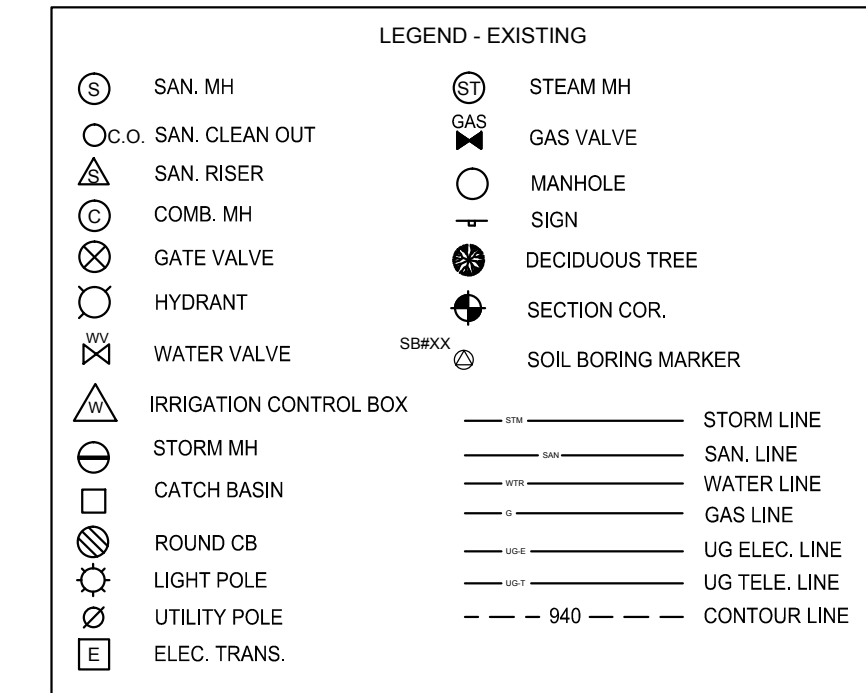
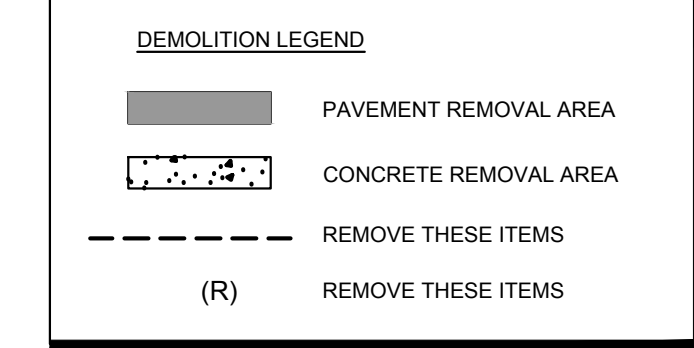

NATURAL RESOURCES NOTES

SOILS: SITE SOILS (PER NRCS WEB SOIL SURVEY)
PRIMARILY CONSIST OF MARLETTE & CAPAC SANDY LOAM

WETLANDS: THERE ARE NO WETLANDS ON SITE

WATER BODIES: THERE ARE NO LAKES, PONDS, BASINS
RIVERS OR STREAMS ON SITE.

WOODLANDS: THERE ARE NO REGULATED WOODLANDS ON SITE.

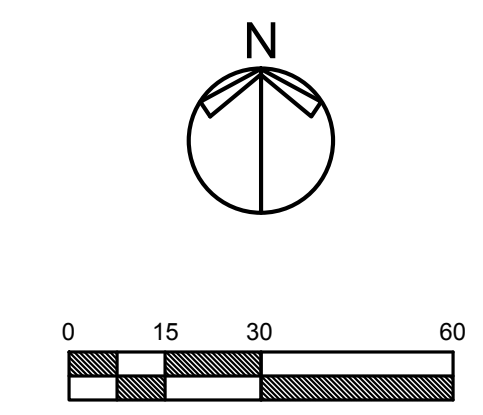

NOTE:
ALL UTILITIES SHOWN ARE APPROXIMATE
LOCATIONS FROM FIELD DATA AND AVAILABLE
INFORMATION. THEY SHOULD NOT BE INTERPRETED
AS EXACT LOCATIONS NOR SHOULD THEY BE
ASSUMED TO BE THE ONLY UTILITIES IN THE AREA.

ARCHITECTS • CIVIL ENGINEERS

paradigm design

550 3 MILE N.W.
SUITE B
GRAND RAPIDS, MI 49544

PHONE (616) 785 • 5656
FAX (616) 785 • 5657
WEB PARADIGMAE.COM

PROJECT

GFS MARKETPLACE

NOVI
LOCATED IN SECTION 15
APPROX. 44225 W. 12 MILE RD
NOVI, MICHIGAN

DEVELOPER:

GFS MARKETPLACE REALTY FIVE, LLC

P.O. BOX 1812
GRAND RAPIDS, MICHIGAN

RELEASE DATE

11-9-12 PRE-APPLICATION MEETING.
12-14-12 PRELIMINARY SITE PLAN REVIEW

PROJECT

1205049

SHEET

G-101

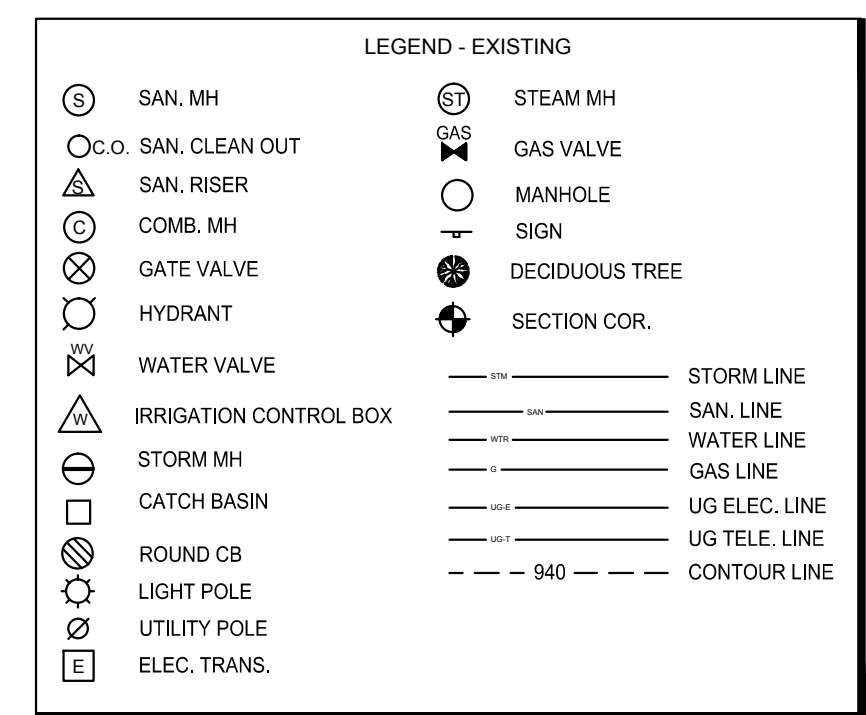
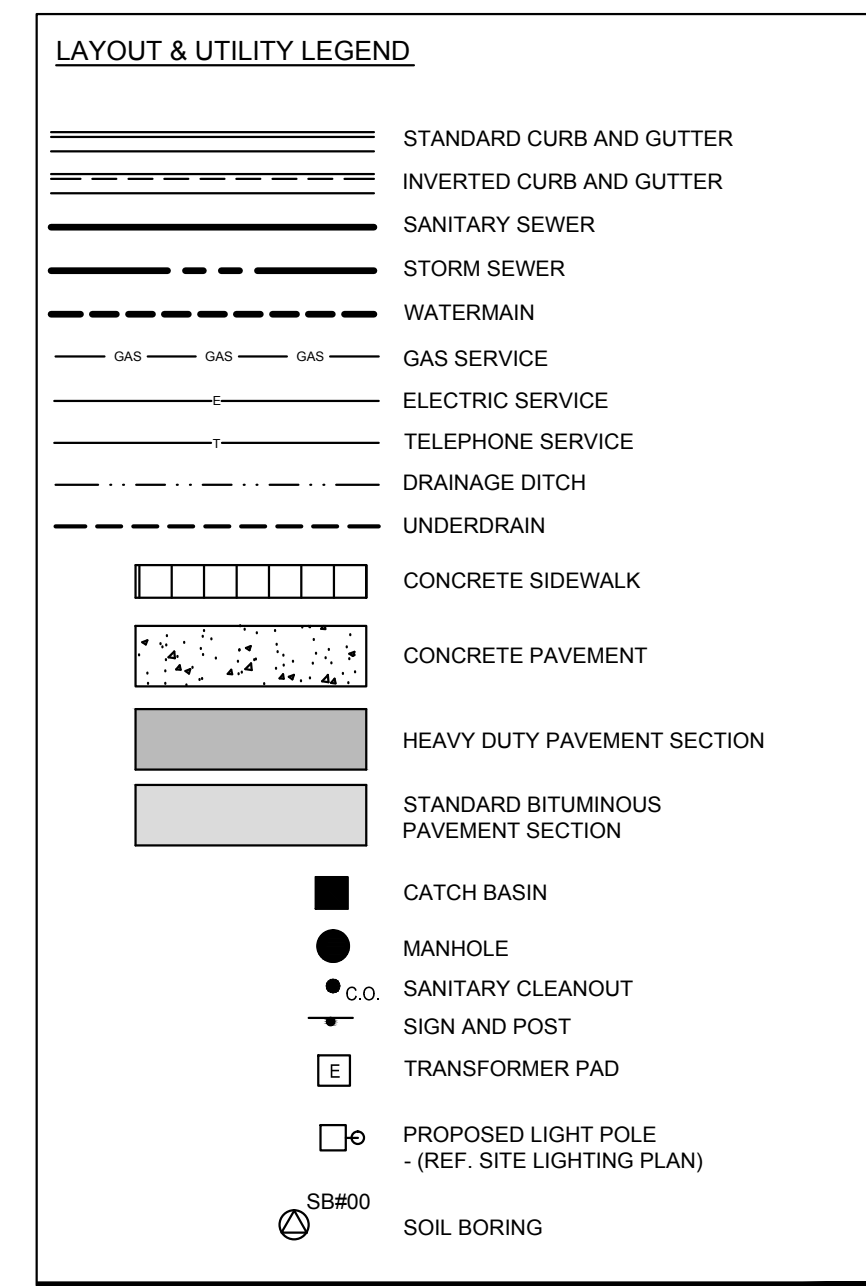
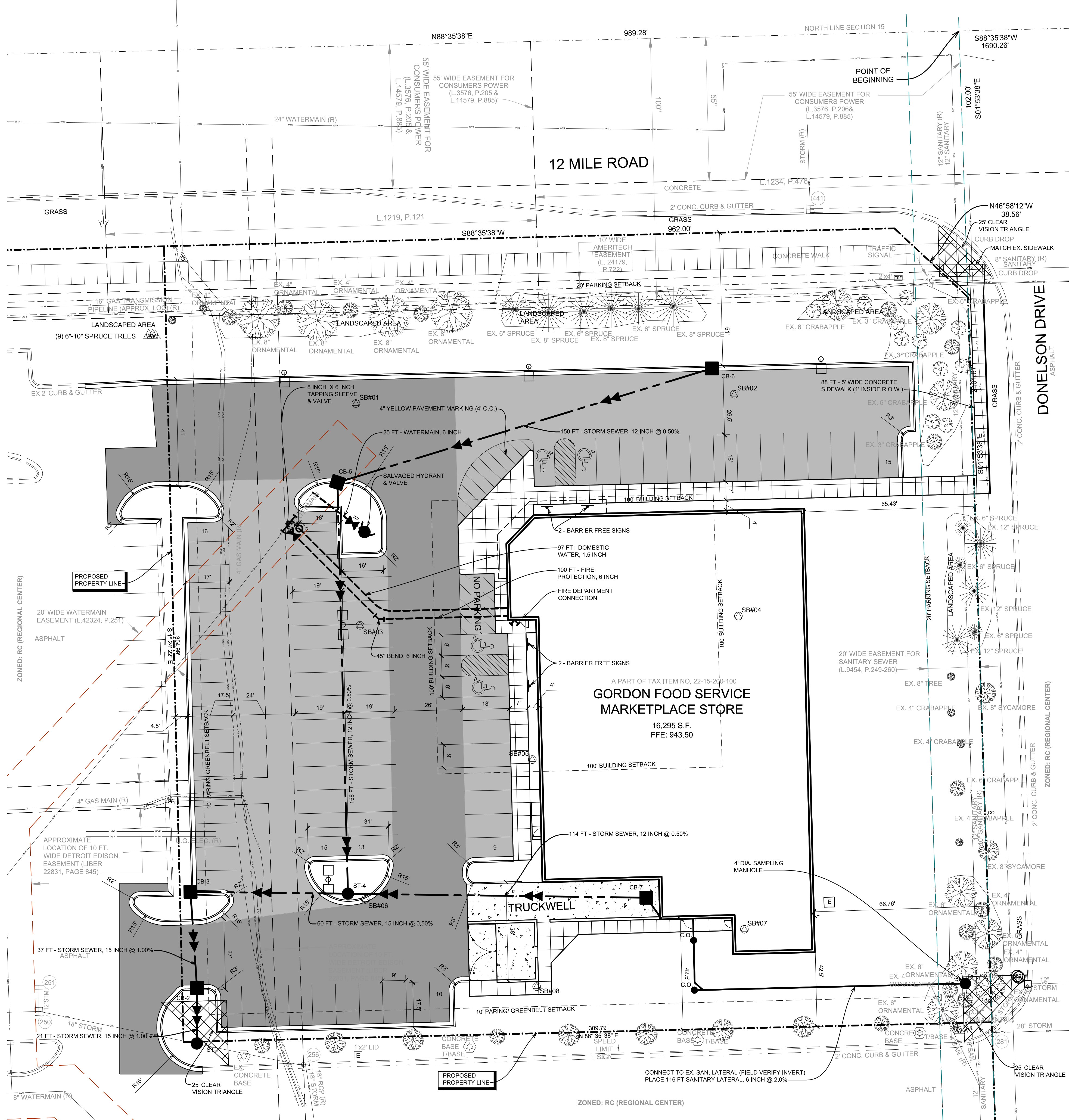

EXISTING STRUCTURE TABLE

CB-250 RIM: 936.97 12" (N) INV: 930.67 12" (W) INV: 929.43 18" (E) INV: 929.07	ST-281 RIM: 940.24 12" (NE) INV: 935.04 28" (E) INV: 932.59
CB-251 RIM: 936.87 12" (S) INV: 931.17	CB-441 RIM: 945.68
CB-256 RIM: 937.30 18" (NW) INV: 928.10 18" (S) INV: 928.10	S-494 RIM: 945.35 12" (N & S) INV: 929.05
S-280 RIM: 940.07 12" (N & S) INV: 927.92	CB-561 RIM: 939.98
	CB-562 RIM: 940.57 12" (SW & E) INV: 940.57

GENERAL SITE NOTES

REFER TO ARCHITECTURAL PLANS FOR DETAILS OF CONCRETE SIDEWALK AROUND BUILDING, CONCRETE TRUCK WELL, BOLLARD DETAIL, AND CONCRETE DUMPSTER PAD.

REFER TO ARCHITECTURAL FOUNDATION PLAN FOR DETAILING OF BUILDING AND EXACT BUILDING DIMENSIONS.

REFER TO LANDSCAPE PLAN FOR ACTUAL LOCATION OF SIGNS AND FOR RESTORATION OF ALL NON PAVED SURFACES.

REFER TO SECTION 02230 OF THE SPECIFICATIONS BOOK FOR SITE CLEARING WORK.

REFER TO SECTION 02260 OF THE SPECIFICATIONS BOOK FOR EXCAVATION SUPPORT AND PROTECTION OF EXISTING UTILITIES AND STRUCTURES.

REFER TO SPECIFICATIONS FOR SITE "RECORD DRAWING" SUBMITTAL REQUIREMENTS.

CONTRACTOR IS RESPONSIBLE TO OBTAIN ALL SITE RELATED PERMITS NOT BEING OBTAINED BY THE OWNER. CONTRACTOR IS REQUIRED TO COMPLETE THE APPLICATION, AND SUBMIT NECESSARY DRAWINGS, FEES, ETC. TO THE APPROPRIATE JURISDICTION. CONTRACTOR SHALL PAY ALL FEES RELATED TO PERMIT(S) AND SECURE PERMIT(S) IN HIS NAME.

CONTRACTOR IS RESPONSIBLE TO COORDINATE ALL SITE UTILITY CONNECTIONS AND INSPECTIONS WITH THE PROPER JURISDICTION AND PAY ALL ASSOCIATED FEES.

THE CONTRACTOR SHALL FIELD VERIFY LOCATION AND ELEVATION OF EXISTING WATER, SANITARY SEWER, AND STORM SEWER CROSSINGS AND CONNECTION POINTS PRIOR TO CONSTRUCTION. CONTACT ENGINEER WITH ANY DISCREPANCIES.

ALL DIMENSIONS SHOWN TO CONCRETE CURB AND GUTTER ARE TO BACK OF CURB UNLESS OTHERWISE NOTED.

CONCRETE GUTTER PAN TO TIP IN THE DIRECTION OF THE ADJACENT PAVEMENT.

ALL PAVEMENT MARKINGS SHALL BE 4" WIDE. STANDARD PARKING SPACES SHALL BE MARKED IN (WHITE) AND BARRIER FREE SPACES IN YELLOW. EACH BARRIER FREE SPACE SHALL BE PROVIDED WITH A PAINTED PAVEMENT SYMBOL, A PRECAST CONCRETE BUMPER BLOCK AND A SIGN PER THE MANUAL OF UNIFORM TRAFFIC CONTROL.

REFERENCE SOILS REPORT IN SPECIFICATION BOOK FOR BORING LOGS AND DESIGN SECTION OF ALL PAVED AREAS.

ALL MDT REFERENCES ARE TO THE 2012 EDITION.

GENERAL STORM SEWER NOTES

STORM CONTRACTOR TO END STORM CONNECTION 5' FROM BUILDING WITH A TEMPORARY CAP. - COORDINATE CONNECTION WITH BUILDING PLUMBING CONTRACTOR.

STORM SEWER PIPE SHALL BE REINFORCED CONCRETE PER ASTM C76 CLASS IV WALL B. JOINTS SHALL BE RUBBER O-RING PER ASTM C443.

UNDERDRAINS SHALL BE SMOOTH INTERIOR CORRUGATED POLYETHYLENE PIPE TYPE S, PER AASHTO M252 AND PRE-WRAPPED WITH A GEOTEXTILE FILTER SOCK.

MATERIALS, INSTALLATION & TESTING OF THE STORM SEWER SYSTEM SHALL CONFORM TO CITY OF NOVI STANDARDS.

GENERAL SANITARY SERVICE NOTES

SITE CONTRACTOR TO END SANITARY LATERAL WITH A CLEAN-OUT AND TEMPORARY CAP/ INSPECTION MANHOLE AT 5' FROM BUILDING. COORDINATE CONNECTION WITH BUILDING PLUMBING CONTRACTOR.

SANITARY SEWER SERVICE LATERAL AND FITTINGS SHALL BE PVC PER ASTM D-3034, SDR-26.

MATERIALS, INSTALLATION AND TESTING OF SANITARY SEWER SERVICES SHALL CONFORM TO CITY OF NOVI STANDARDS.

GENERAL WATER SERVICE NOTES

SITE CONTRACTOR TO END WATER SERVICE(S) 12" ABOVE FINISHED FLOOR INSIDE BUILDING AND INSTALL TEMPORARY CAP. COORDINATE WITH BUILDING PLUMBING CONTRACTOR.

DOMESTIC SERVICE TO BE TAPPED OFF FIRE SERVICE INSIDE BUILDING.

IRRIGATION WATER SERVICE TO BE TAPPED OFF WATER SERVICE INSIDE BUILDING UTILITY ROOM. COORDINATE WITH LANDSCAPER AND BUILDING PLUMBER.

FIRE PROTECTION LINE AND COMBINED SERVICE LINE SHALL BE DUCTILE IRON PER ANSI/AWWA C151/A21.51, THICKNESS CLASS 54 PER ANSI/AWWA C110/A21.50. FITTINGS SHALL BE DUCTILE IRON PER ANSI/AWWA C110/A21.10, PRESSURE CLASS 550.

MINIMUM DEPTH OF BURY SHALL BE 66".

MATERIALS, INSTALLATION AND TESTING OF WATER SERVICE LINES SHALL CONFORM TO CITY OF NOVI STANDARDS AND THE STATE PLUMBING CODE.

SITE DATA

ZONED: RC (REGIONAL CENTER DISTRICT)

SITE: 2.15 ± AC. (PROPOSED)

REQUIRED PARKING: 78
(1 PER 200 SF OF GLA: 15,670 S.F.)

PROVIDED PARKING: 78
(INCLUDES 4 BARRIER FREE SPACES)

REQUIRED LOADING AREA: 1,030 S.F.
(10 SF PER FT. BLDG FRONTAGE)

PROVIDED LOADING AREA: 1,056 S.F.
(CONCRETE TRUCKWELL)

REQUIRED INTERIOR LANDSCAPING: 2,514 SF
(10% OF PARKING AREA + 5% OF OTHER PAVED AREA)

PROVIDED INTERIOR LANDSCAPING: 2,568 SF

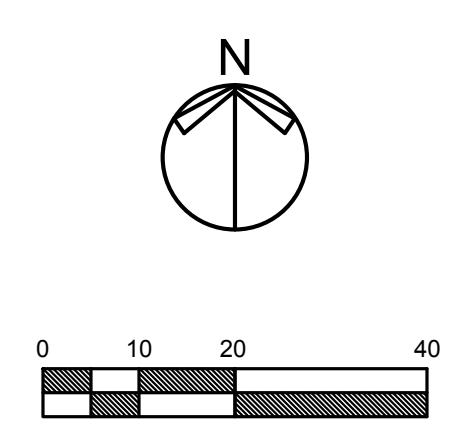

ARCHITECTS • CIVIL ENGINEERS

paradigm design

550 3 MILE N.W.
SUITE B
GRAND RAPIDS, MI 49544

PHONE (616) 785 - 5656
FAX (616) 785 - 5657
WEB PARADIGM.AE.COM

JOHN R. WALSH
ENGINEER
MICHIGAN PROFESSIONAL REGISTERED
12/1/12

JOHN R. WALSH
M - REGISTRATION # 6201038597
EXP. DATE 10/31/2013

PROJECT

GFS MARKETPLACE

NOVI
LOCATED IN SECTION 15
APPROX. 44225 W. 12 MILE RD
NOVI, MICHIGAN

DEVELOPER:

GFS MARKETPLACE REALTY FIVE, LLC

P.O. BOX 1812
GRAND RAPIDS, MICHIGAN

RELEASE DATE

11-9-12 PRE-APPLICATION MEETING
12-14-12 PRELIMINARY SITE PLAN REVIEW

PROJECT

1205049

SHEET

G-102

Wednesday, December 19, 2012 at 12:10pm 0:\205049\GFS_Nova_MW\dwg\G-102.dwg jrw



UNIFIED KEYING SYSTEM SOIL EROSION AND SEDIMENTATION CONTROL MEASURES

CONSTRUCTION SEQUENCE	YEAR: 2013											
	JAN.	FEB.	MAR.	APR.	MAY	JUNE	JULY	AUG.	SEP.	OCT.	NOV.	DEC.
STRIPPING & STOCKPILING TOPSOIL												
ROUGH GRADING SEDIMENT CONTROL												
TEMPORARY CONTROL MEASURES												
STORM UTILITIES												
TEMPORARY CONSTRUCTION ROADS												
PERMANENT CONTROL MEASURES												
FOUNDATION/BUILDING CONSTRUCTION												
SITE CONSTRUCTION												
FINISH GRADING												
LANDSCAPING												

GENERAL CONTRACTOR SHALL COMPLETE CONSTRUCTION SEQUENCE SCHEDULE WHEN MAKING APPLICATION FOR SOIL EROSION CONTROL PERMIT

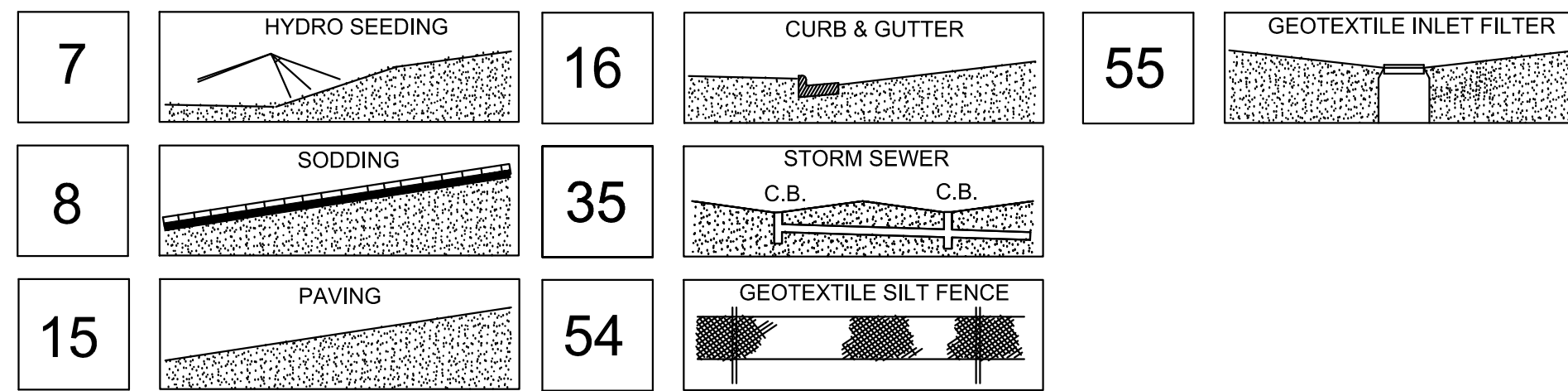

GRADING AND SOIL EROSION & SEDIMENTATION CONTROL LEGEND

923.00	PROPOSED SPOT GRADE
→	SURFACE WATER FLOW DIRECTION
BIT	PROPOSED BITUMINOUS GRADE
CON	PROPOSED CONCRETE GRADE
FW	PROPOSED FRONT OF WALK GRADE
BW	PROPOSED BACK OF WALK GRADE
RIM	PROPOSED CATCH BASIN FLOWLINE GRADE
TC	TOP OF CURB GRADE
FL	FLOW LINE GRADE
MATCH EX.	MATCH EXISTING ELEVATION
# P	PERMANENT SOIL EROSION & SEDIMENTATION CONTROL MEASURE
# T	TEMPORARY SOIL EROSION & SEDIMENTATION CONTROL MEASURE

TYP.	TYPICAL MEASURE
[Symbol]	STANDARD CURB AND GUTTER
[Symbol]	INVERTED CURB AND GUTTER
[Symbol]	SANITARY SEWER
[Symbol]	STORM SEWER
[Symbol]	WATER MAIN
[Symbol]	GAS SERVICE
[Symbol]	ELECTRIC SERVICE
[Symbol]	TELEPHONE SERVICE
[Symbol]	STORM WATER BREAK LINE
[Symbol]	DRAINAGE DITCH
[Symbol]	UNDERDRAIN
[Symbol]	PROPOSED CONTOUR
[Symbol]	EXISTING CONTOUR
[Symbol]	SILT FENCE
[Symbol]	GRADING LIMITS
[Symbol]	CONCRETE SIDEWALK
[Symbol]	CONCRETE PAVEMENT
[Symbol]	HEAVY DUTY PAVEMENT SECTION
[Symbol]	STANDARD BITUMINOUS PAVEMENT SECTION
[Symbol]	CATCH BASIN
[Symbol]	MANHOLE
[Symbol]	SANITARY CLEANOUT
[Symbol]	SIGN AND POST
[Symbol]	TRANSFORMER PAD
[Symbol]	REF. MECHANICAL DRAWINGS
[Symbol]	PROPOSED LIGHT POLE
[Symbol]	REF. SITE LIGHTING PLAN

GENERAL SOIL EROSION AND SEDIMENTATION CONTROL NOTES:

- THE OWNER WILL OBTAIN THE SOIL EROSION PERMIT FROM THE PROPER GOVERNING AUTHORITY.
- A CONTRACTOR/INSPECTOR SHALL INSPECT THE SOIL EROSION/SEDIMENTATION CONTROL DEVICES ONCE EACH WEEK AND/OR WITHIN 24 HOURS OF A PRECIPITATION EVENT WHICH RESULTS IN A STORM DISCHARGE FROM THE SITE.
- ALL DISTURBED NON-PAVEMENT AREAS MUST BE RESTORED WITH TOPSOIL, SEED, FERTILIZER, AND MULCH UNLESS SODDED. (REFERENCE LANDSCAPING PLAN)
- ALL SLOPES STEEPER THAN 1:3 SHALL USE AN EROSION CONTROL BLANKET (NORTH AMERICAN GREEN S100B OR EQUAL). ALL SLOPES BETWEEN 1:4 AND 1:3 SHALL USE AN EROSION CONTROL BLANKET (NORTH AMERICAN GREEN DS75 OR EQUAL), UNLESS INDICATED OTHERWISE ON PLANS.
- SEEDING SHOULD BE PREPARED ACCORDING TO THE MANUFACTURER'S RECOMMENDATIONS. THE CONTRACTOR/INSPECTOR SHALL INSPECT THE AREA AFTER SEEDING IS COMPLETED. AREAS THAT ARE BARE OR NOT MULCHED PROPERLY WILL NEED TO BE SPOT SEEDED AND/OR RE-MULCHED.
- SILT FENCE SHOULD BE TRENCHED IN, BACKFILLED, AND STAPLED OR STAKED ACCORDING TO THE MANUFACTURER'S SPECIFICATIONS. MAINTENANCE INCLUDES THE REMOVING OF BUILT-UP SEDIMENT WHEN THE SEDIMENT ACCUMULATES TO 1/3 TO 1/2 THE HEIGHT OF THE FENCE. CONTRACTOR WILL HAVE TO REMOVE, REPLACE, RETRENCH, OR REBACKFILL THE FENCE IF IT FAILS. IT WOULD ALSO BE NECESSARY TO REINSTALL IF ANY PORTION OF THE FENCING WAS DAMAGED BY CONSTRUCTION MACHINERY.
- INLET FILTERS SHALL BE SILT SACKS, DANDY BAGS OR APPROVED EQUAL. INLET FILTERS SHOULD BE INSPECTED FOR BUILDUP OF SILT AND OTHER DEBRIS. THIS IS ESSENTIAL IF STRUCTURE IS CAUSING FLOODING. MAINTENANCE WOULD CONSIST OF REMOVING OF SEDIMENTS OR REPLACING FILTER AS NECESSARY.
- SOIL EROSION CONTROL METHODS SHOWN ARE A GUIDELINE AND DO NOT RELIEVE THE CONTRACTOR FROM ADDITIONAL METHODS THAT MAY BE REQUIRED BY THE SOIL EROSION CONTROL PERMIT.
- THE CONTRACTOR SHALL ENGAGE A CERTIFIED STORM WATER OPERATOR IN ACCORDANCE WITH EPA PHASE II RULES TO MEET REQUIREMENTS OR THE PERMIT. THIS OPERATOR WILL INSPECT THE JOB SITE AS REQUIRED BY RULE. NOTIFY JOB SITE SUPERINTENDENT OF ANY DEFICIENCIES AND ENTER FINDINGS IN THE JOB SITE INSPECTION JOB BOOK.

PROPOSED STRUCTURE TABLE	
STRUCTURE NAME	STRUCTURE DETAILS
CB-2	48" DIA. STORM STRUCTURE RIM: 937.87 15" (N) INV: 934.56 15" (S) INV: 933.56
CB-3	48" DIA. STORM STRUCTURE RIM: 938.72 15" (E) INV: 935.03 15" (S) INV: 934.93
CB-5	48" DIA. STORM STRUCTURE RIM: 942.33 12" (E) INV: 936.32 12" (S) INV: 936.22
CB-6	48" DIA. STORM STRUCTURE RIM: 941.68 12" (W) INV: 937.07
CB-7	48" DIA. STORM STRUCTURE RIM: 939.50 12" (W) INV: 936.00
ST-1	48" DIA. STORM STRUCTURE RIM: 937.77 15" (N) INV: 933.35
ST-4	48" DIA. STORM STRUCTURE RIM: 940.81 12" (N) INV: 935.43 12" (E) INV: 935.43 15" (W) INV: 935.33

LEGEND - EXISTING

[Symbol]	SAN. MH	[Symbol]	STEAM MH
[Symbol]	SAN. CLEAN OUT	[Symbol]	GAS VALVE
[Symbol]	SAN. RISER	[Symbol]	MANHOLE
[Symbol]	COMB. MH	[Symbol]	SIGN
[Symbol]	GATE VALVE	[Symbol]	DECIDUOUS TREE
[Symbol]	HYDRANT	[Symbol]	SECTION COR.
[Symbol]	WATER VALVE	[Symbol]	STORM LINE
[Symbol]	IRRIGATION CONTROL BOX	[Symbol]	SAN. LINE
[Symbol]	STORM MH	[Symbol]	WATER LINE
[Symbol]	CATCH BASIN	[Symbol]	GAS LINE
[Symbol]	ROUND CB	[Symbol]	UG ELEC. LINE
[Symbol]	LIGHT POLE	[Symbol]	UG TELE. LINE
[Symbol]	UTILITY POLE	[Symbol]	CONTOUR LINE
[Symbol]	ELEC. TRANS.		

EXISTING STRUCTURE TABLE

CB-250 RIM: 936.87 12" (N) INV: 930.67 12" (W) INV: 929.43 18" (SE) INV: 929.07	ST-281 RIM: 940.24 12" (NE) INV: 935.04 28" (E) INV: 932.59
CB-251 RIM: 936.87 12" (S) INV: 931.17	CB-441 RIM: 945.68
CB-256 RIM: 937.30 18" (NW) INV: 928.10 18" (S) INV: 928.10	S-494 RIM: 945.35 12" (N & S) INV: 929.05
S-280 RIM: 940.07 12" (N & S) INV: 927.92	CB-561 RIM: 939.98
	CB-562 RIM: 940.57 12" (SW & E) INV: 940.57

STORM WATER DESIGN NOTES
EX. RUNOFF COEFFICIENT (C) = 0.75
(PER FOUNTAIN WALK PLAN C33 - 3/16/01)
PROPOSED IMPERVIOUS AREA = 1.33± AC. (C = 0.95)
PROPOSED GRASS AREA = 0.82± AC. (C = 0.35)
PROPOSED WEIGHTED C = 0.72

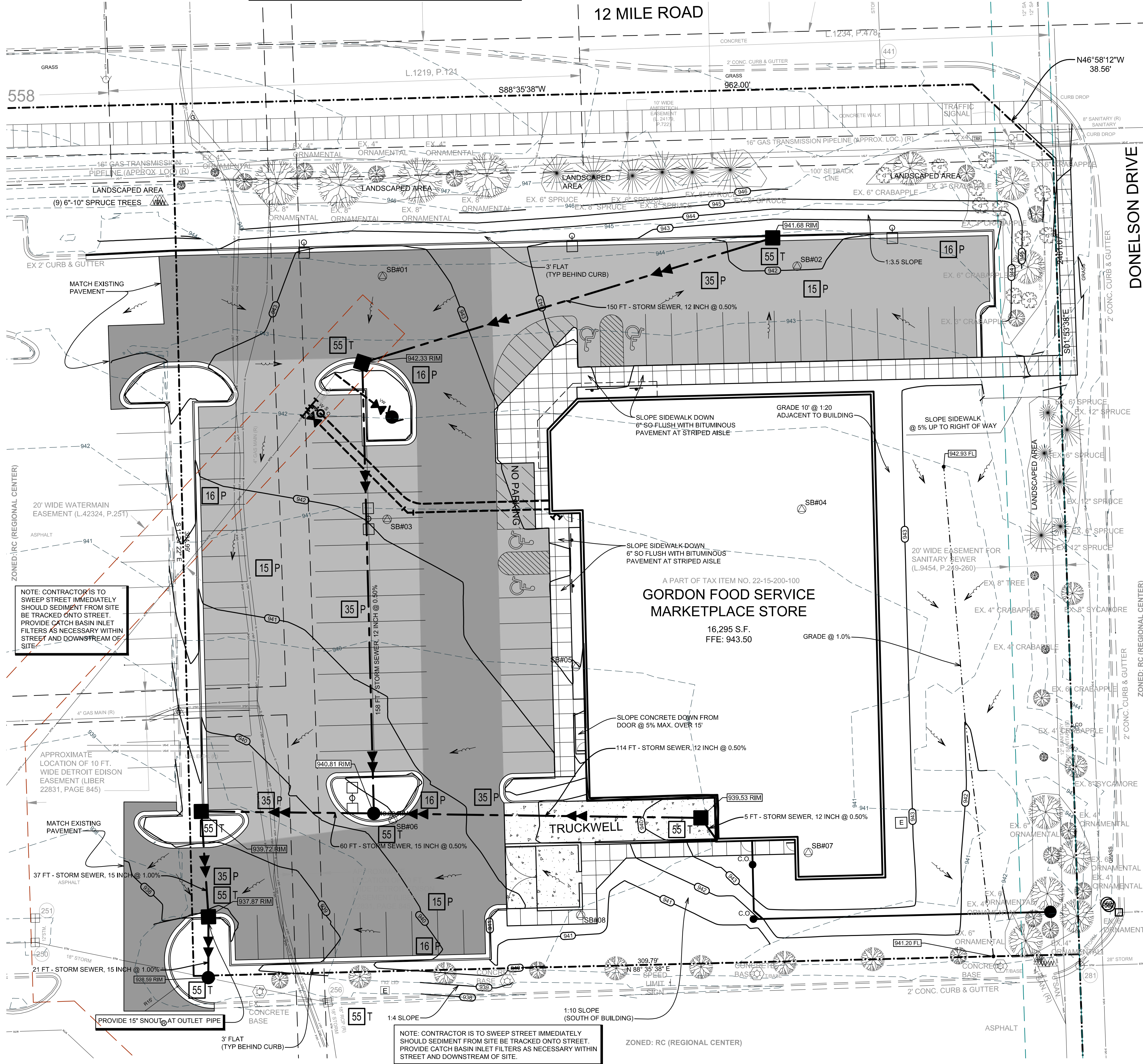
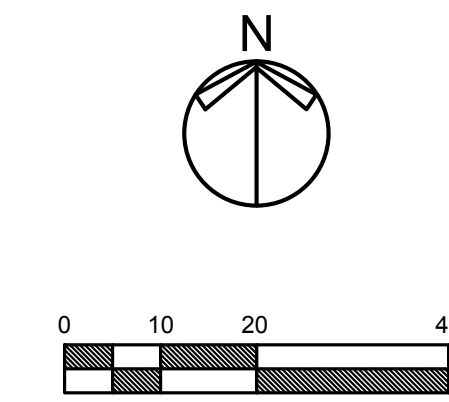

NOTE: CONTRACTOR IS TO SWEEP STREET IMMEDIATELY SHOULD SEDIMENT FROM SITE BE TRACKED ONTO STREET. PROVIDE CATCH BASIN INLET FILTERS AS NECESSARY WITHIN STREET AND DOWNSTREAM OF SITE.

NOTE: CONTRACTOR IS TO SWEEP STREET IMMEDIATELY SHOULD SEDIMENT FROM SITE BE TRACKED ONTO STREET. PROVIDE CATCH BASIN INLET FILTERS AS NECESSARY WITHIN STREET AND DOWNSTREAM OF SITE.

ARCHITECTS • CIVIL ENGINEERS

paradigm design

550 3 MILE N.W.
SUITE B
GRAND RAPIDS, MI 49544

PHONE (616) 785 - 5656
FAX (616) 785 - 5657
WEB PARADIGMAE.COM

STATE OF MICHIGAN
JOHN R. WALSH
ENGINEER
M.I.C.E. REG. NO. 6201052857
EXP. DATE 12/31/2013

PROJECT

GFS MARKETPLACE

NOVI
LOCATED IN SECTION 15
APPROX. 44225 W. 12 MILE RD
NOVI, MICHIGAN

DEVELOPER:

GFS MARKETPLACE REALTY FIVE, LLC

P.O. BOX 1812
GRAND RAPIDS, MICHIGAN

RELEASE DATE

11-9-12 PRE-APPLICATION MEETING
12-14-12 PRELIMINARY SITE PLAN REVIEW

PROJECT

1205049

SHEET

G-103

3 WORKING DAYS
BEFORE YOU DIG CALL MISS DIG.
1-800-482-7171

NOTE: ALL UTILITIES SHOWN ARE APPROXIMATE LOCATIONS FROM FIELD DATA AND AVAILABLE INFORMATION. THEY SHOULD NOT BE INTERPRETED AS EXACT LOCATIONS NOR SHOULD THEY BE ASSUMED TO BE THE ONLY UTILITIES IN THE AREA.

STORM WATER MANAGEMENT PLAN

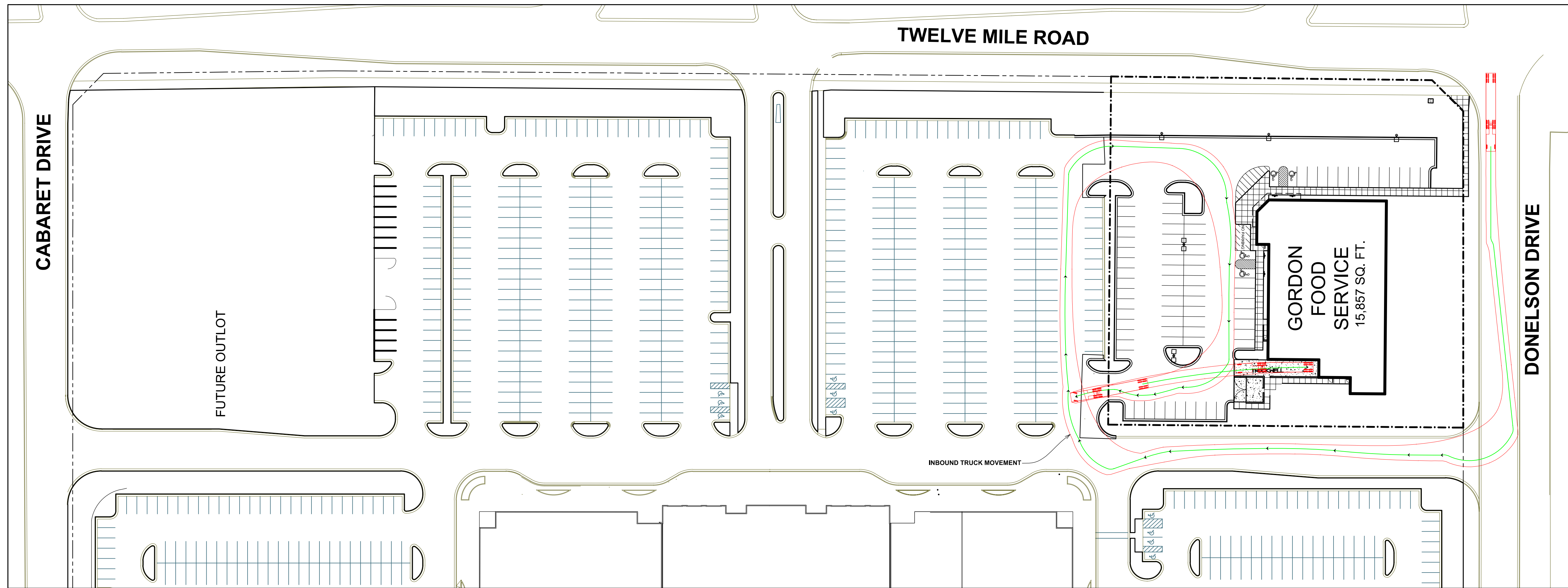

INBOUND TRUCK MOVEMENT

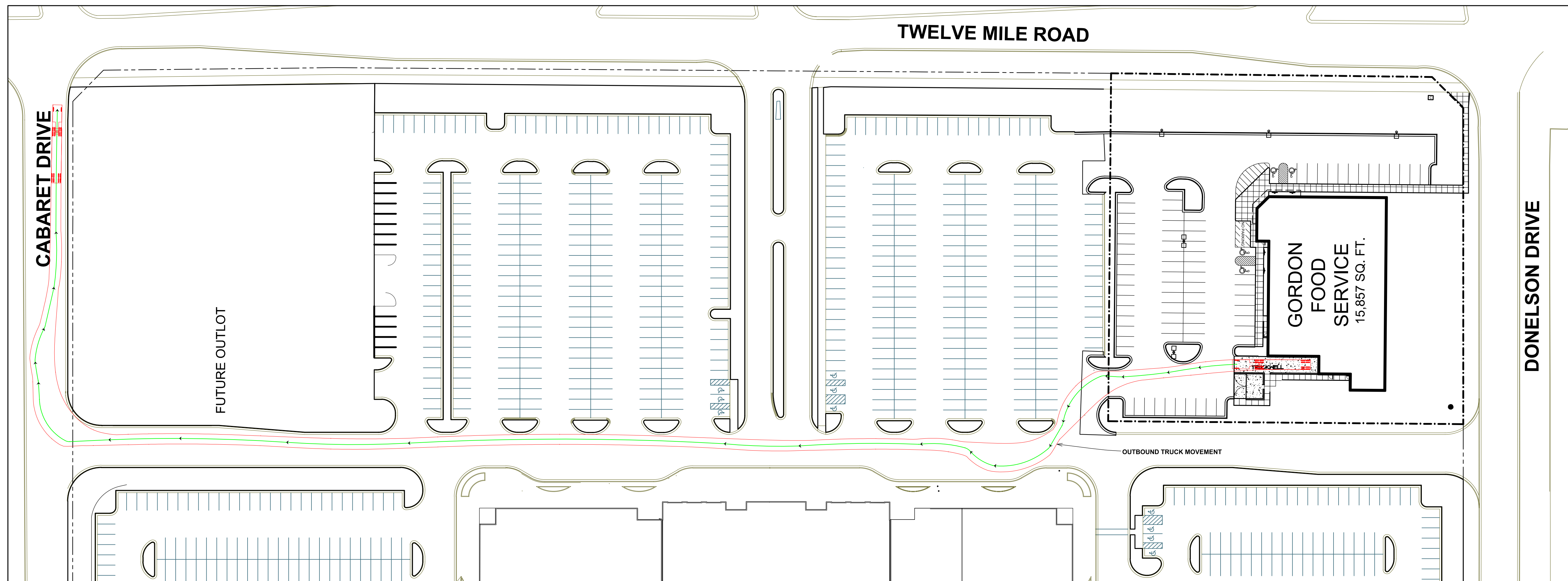

OUTBOUND TRUCK MOVEMENT

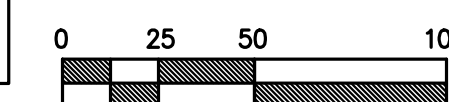
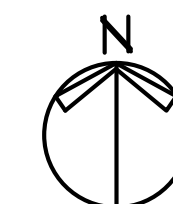

ARCHITECTS • CIVIL ENGINEERS

pd paradigm design

550 3 MILE N.W.
SUITE B
GRAND RAPIDS, MI 49544

PHONE (616) 785 - 5656
FAX (616) 785 - 5657
WEB PARADIGMAE.COM

STATE OF MICHIGAN
JOHN R. WALSH
ENGINEER
LICENSE NO. 6201053857
EXPIRES 10/31/2013

PROJECT

GFS MARKETPLACE

NOVI
LOCATED IN SECTION 15
APPROX. 44225 W. 12 MILE RD
NOVI, MICHIGAN

DEVELOPER:

GFS MARKETPLACE REALTY FIVE, LLC

P.O. BOX 1812
GRAND RAPIDS, MICHIGAN

RELEASE DATE

12-14-12 PRELIMINARY SITE PLAN REVIEW

PROJECT

1205049

SHEET

C-104

TRUCK MANEUVERING PLAN

Wednesday, December 19, 2012 at 12:06pm 0:\1205049 GFS New MI\Drawings\CAD - Project\1205049\049-C-104.dwg jrw

12 Mile Road Right of Way Planting Requirements:

Canopy or Evergreen Trees Required: 13
 Canopy or Evergreen Trees Provided: 13
 Sub-Canopy Trees Required: 20
 Sub-Canopy Trees Proposed: 20

Proposed Plant List

Quantity	Common Name	Latin Name	Planted Size	Root Ball
5	Red Sunset Maple	Acer rubrum 'Franksred'	8" cal.	B & B
5	Serbian Spruce	Picea omorika	8" ht.	B & B
32	Little Leaf Linden	Tilia cordata	8" cal.	B & B
7	Juneberry	Amelanchier Canadensis	2 1/2" cal./7-8" ht. multi-stem	B & B
24	Green Velvet Boxwood	Buxus 'Green Velvet'	24" ht.	Container
25	Dark Horse Weigela	Weigela florida 'Dark Horse'	3 gal.	Container

(note: for ordinance purposes only, the landscape contractor is responsible for what is shown on the landscape plan)

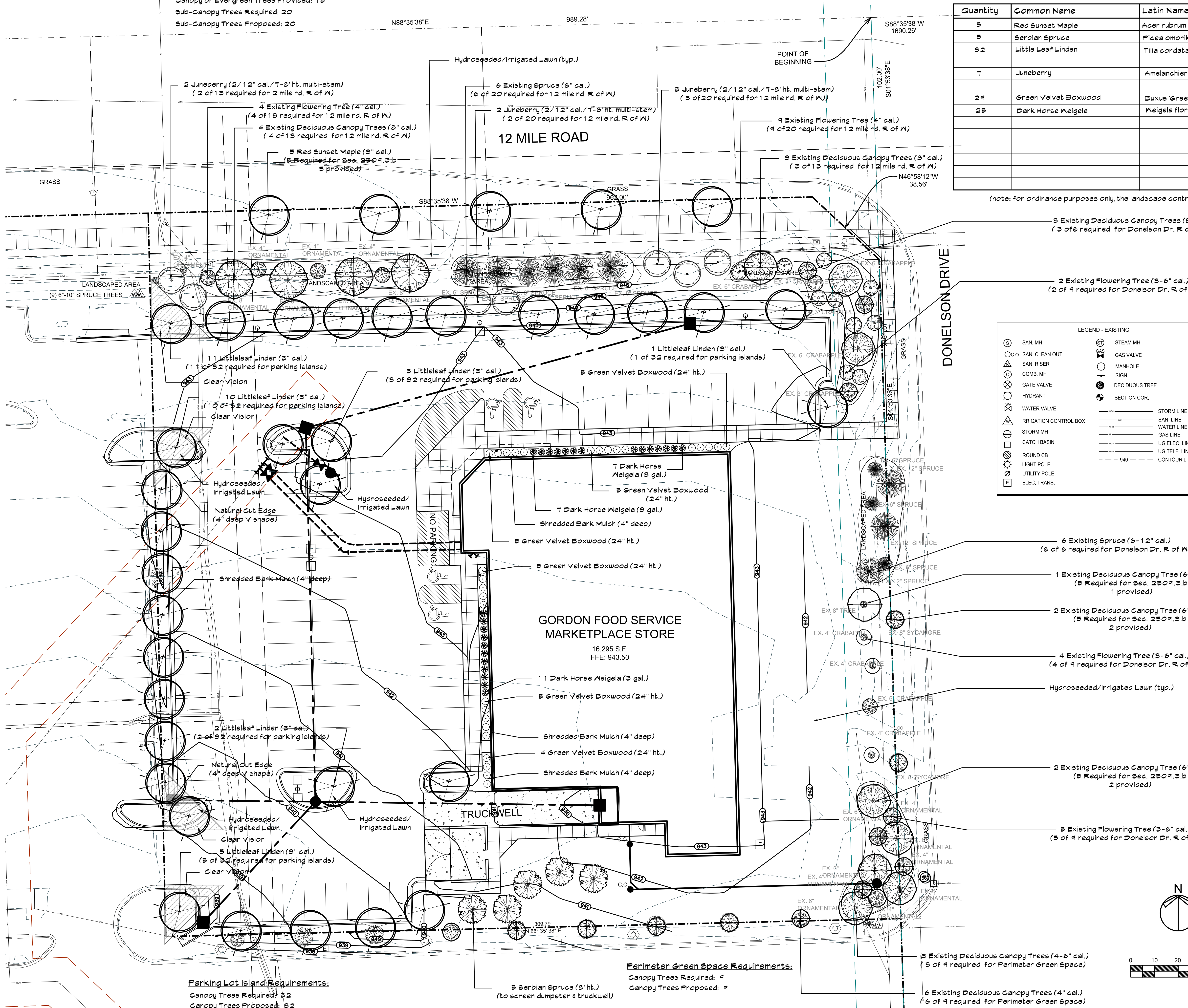

LEGEND - EXISTING

- SAN. MH
- SAN. CLEAN OUT
- SAN. RISER
- COMB. MH
- GATE VALVE
- HYDRANT
- WATER VALVE
- IRRIGATION CONTROL BOX
- STORM MH
- CATCH BASIN
- ROUND CB
- LIGHT POLE
- UTILITY POLE
- ELEC. TRANS.
- STEAM MH
- GAS VALVE
- MANHOLE
- SIGN
- DECIDUOUS TREE
- SECTION COR.
- STORM LINE
- SAN. LINE
- WATER LINE
- GAS LINE
- US ELEC. LINE
- UG TELE. LINE
- CONTOUR LINE

Donelson Dr. Right of Way Planting Requirements:
 Canopy or Evergreen Trees Required: 6
 Canopy or Evergreen Trees Provided: 6
 Sub-Canopy Trees Required: 9
 Sub-Canopy Trees Proposed: 9

Parking Lot Island Requirements:
 Canopy Trees Required: 32
 Canopy Trees Proposed: 32

Perimeter Green Space Requirements:
 Canopy Trees Required: 9
 Canopy Trees Proposed: 9



Joyce E. Weise
 7557 40th Ave.
 Hudsonville, Michigan 49426
 616-669-8004

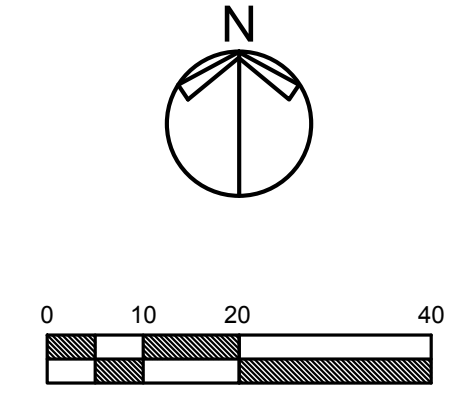

THIS DOCUMENT IS PRELIMINARY IN NATURE AND IS NOT A FINAL, SIGNED AND SEALED DOCUMENT.

NOTE: ALL UTILITIES SHOWN ARE APPROXIMATE LOCATIONS FROM FIELD DATA AND AVAILABLE INFORMATION. THEY SHOULD NOT BE INTERPRETED AS EXACT LOCATIONS NOR SHOULD THEY BE ASSUMED TO BE THE ONLY UTILITIES IN THE AREA.

ARCHITECTS • CIVIL ENGINEERS
paradigm design
 550 3 MILE N.W.
 SUITE 8
 GRAND RAPIDS, MI 49544
 PHONE (616) 785 - 5656
 FAX (616) 785 - 5657
 WEB PARADIGMAE.COM

PROJECT
GFS MARKETPLACE

NOVI
 LOCATED IN SECTION 15
 APPROX. 44225 W. 12 MILE RD
 NOVI, MICHIGAN

DEVELOPER:
GFS MARKETPLACE REALTY FIVE, LLC
 P.O. BOX 1812
 GRAND RAPIDS, MICHIGAN

RELEASE DATE

PROJECT
1205049

SHEET

Thursday, December 20, 2012 at 8:11am 0:1205049 GFS New MI Drawings Civil 3D - Project #1205049/049-0102.dwg Pw

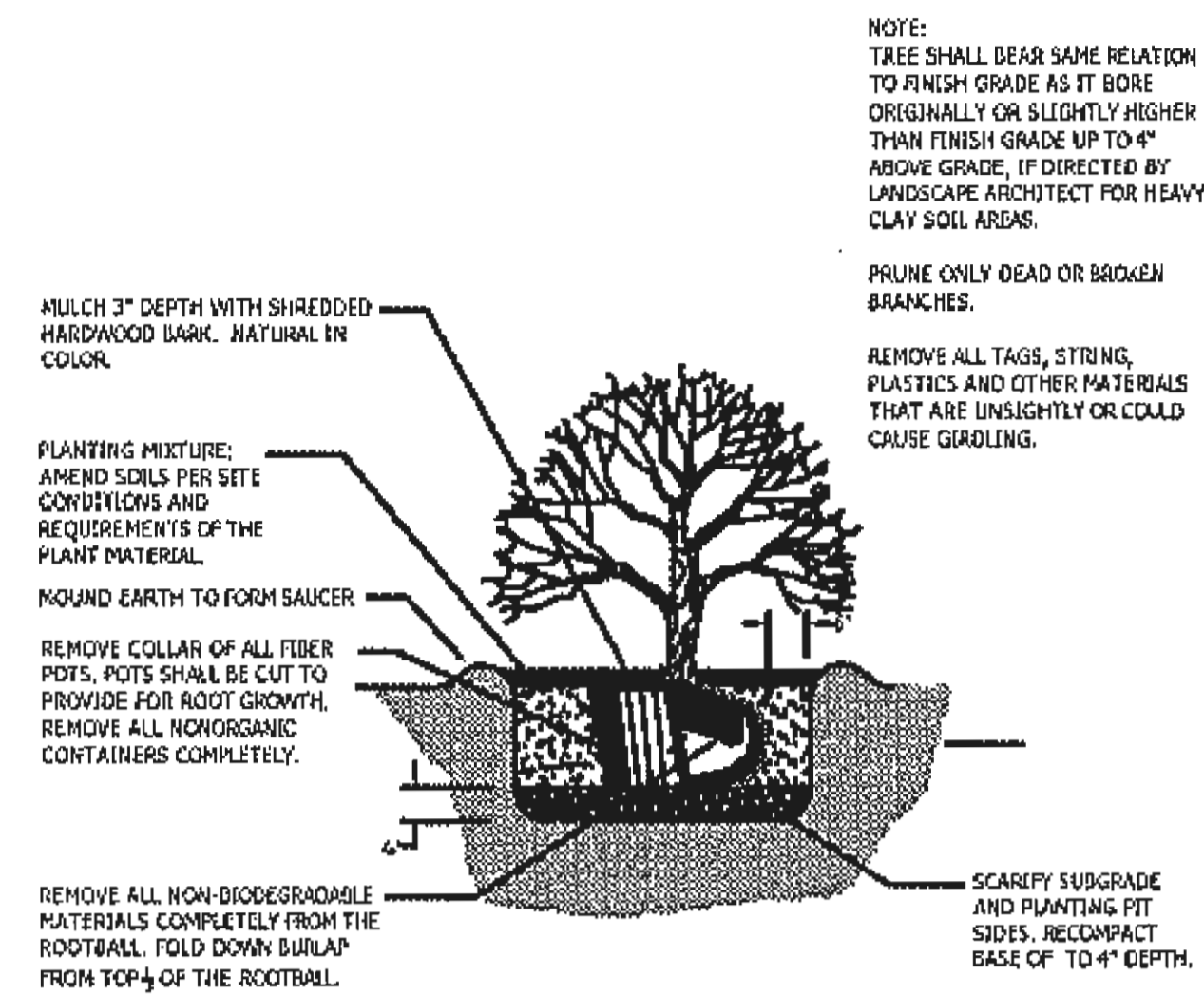

SHRUB PLANTING DETAIL

NOT TO SCALE

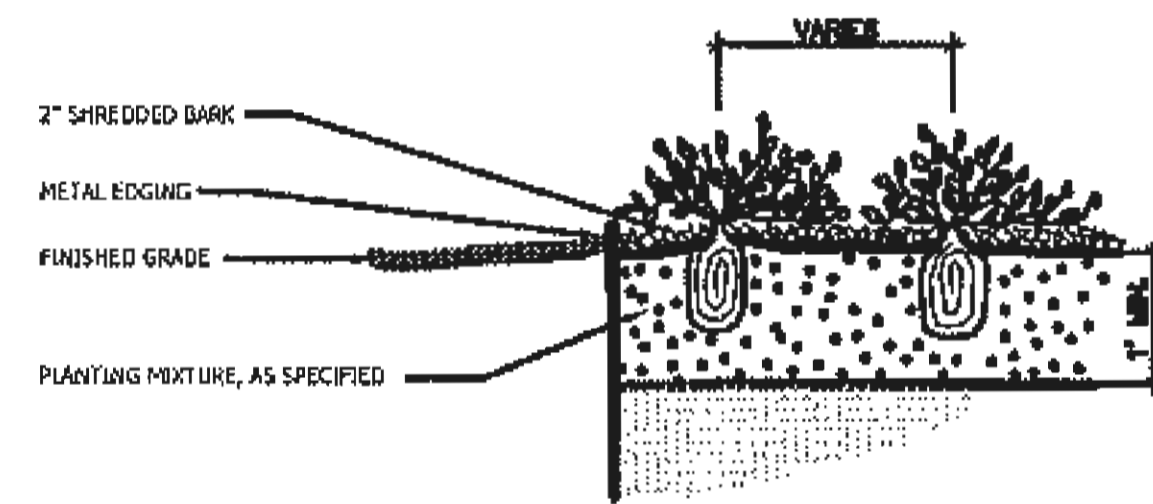

PERENNIAL PLANTING DETAIL

NOT TO SCALE

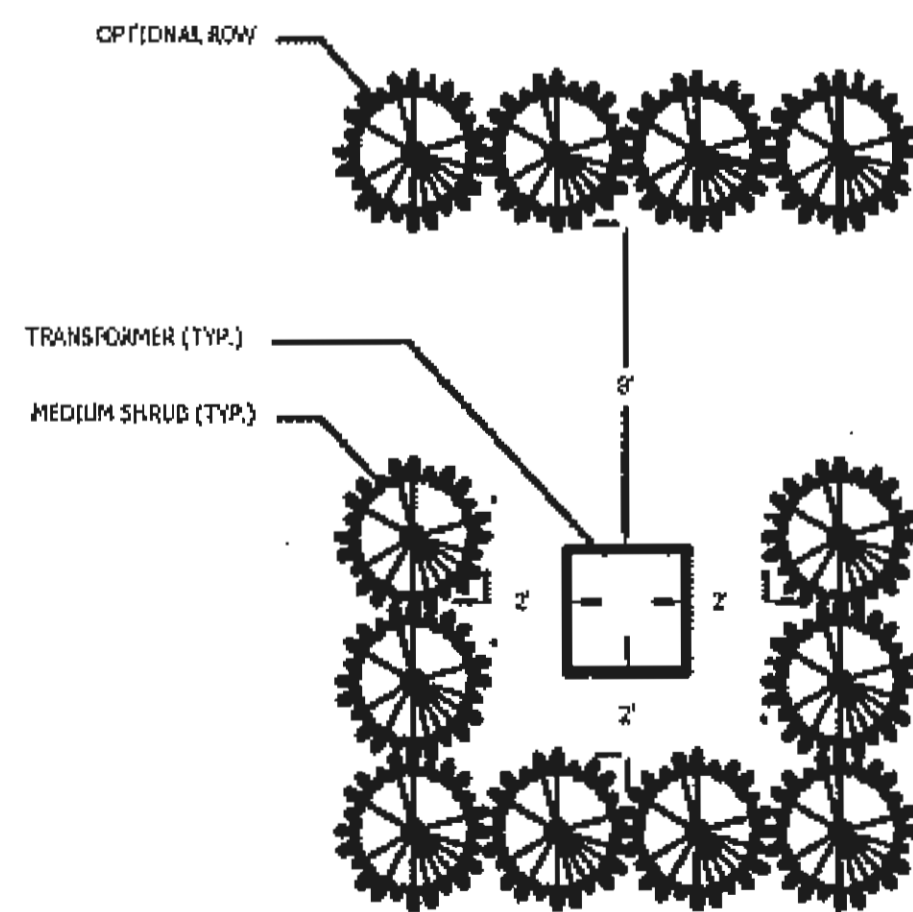

TRANSFORMER SCREENING DETAIL

NOT TO SCALE

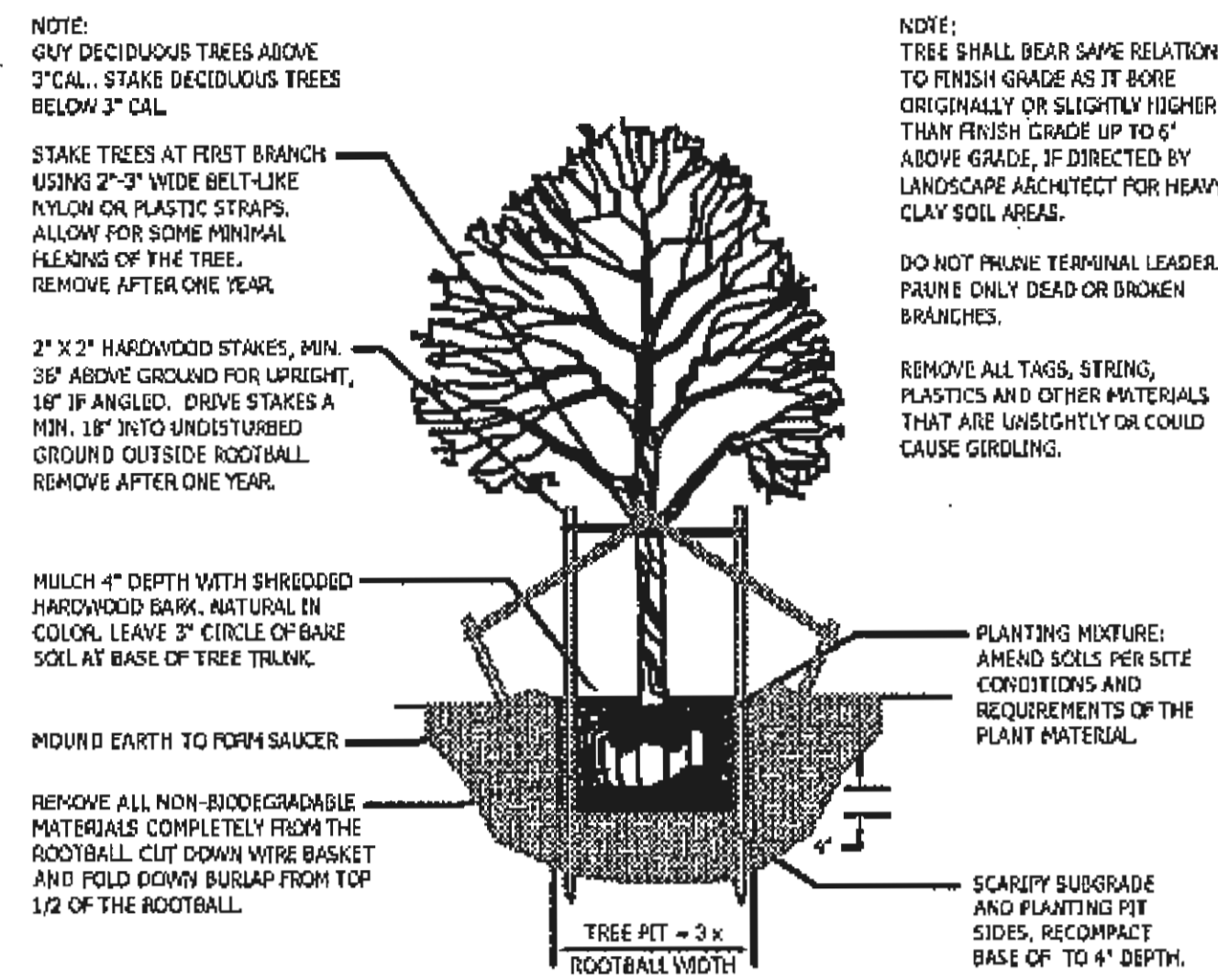

DECIDUOUS TREE PLANTING DETAIL

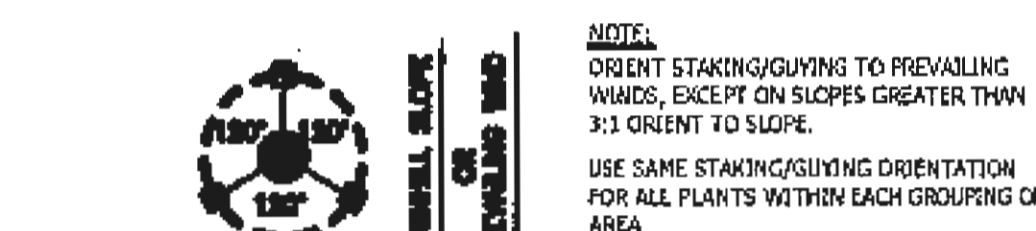

TREE STAKING DETAIL

NOT TO SCALE

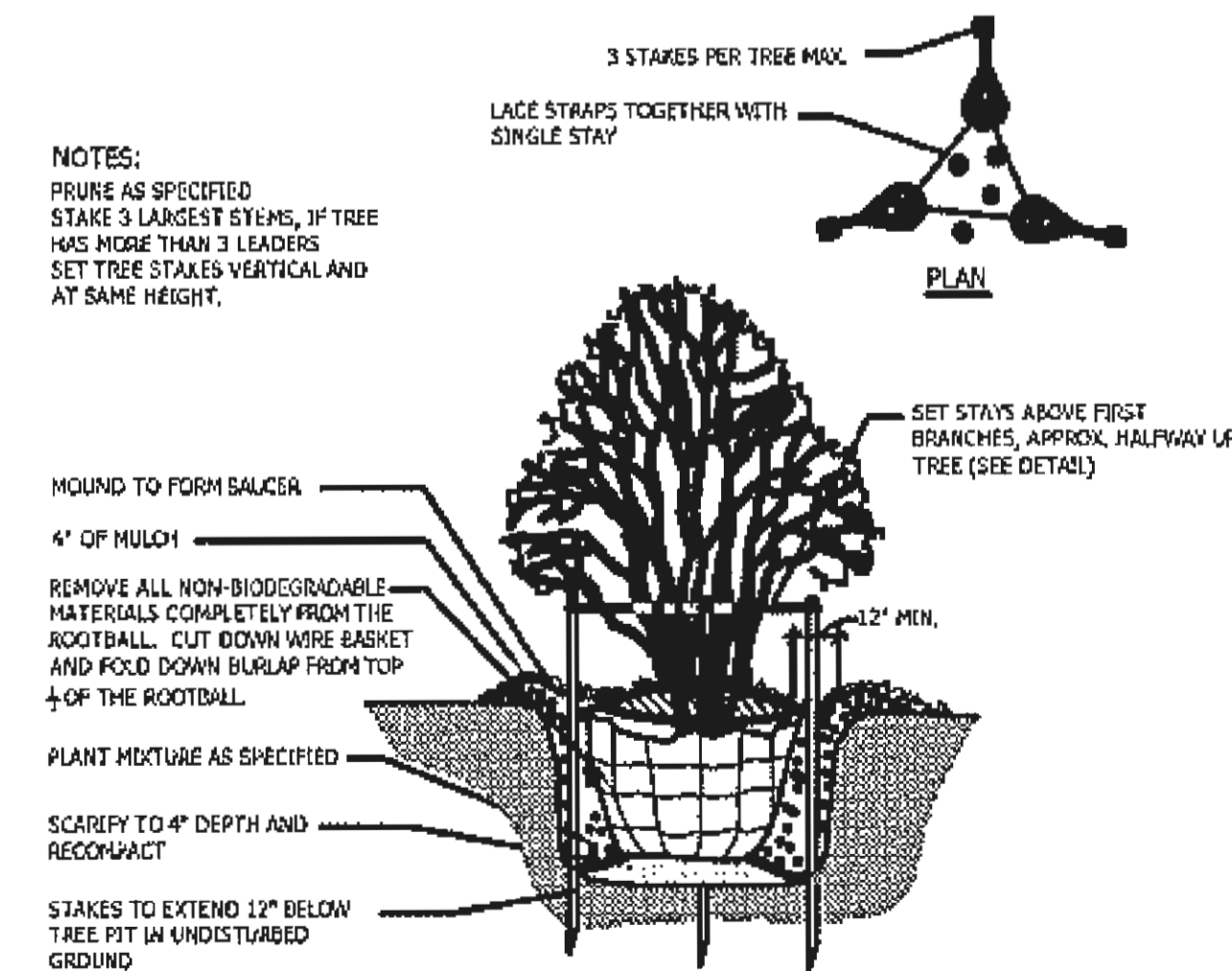

MULTI-STEM TREE PLANTING DETAIL

NOT TO SCALE

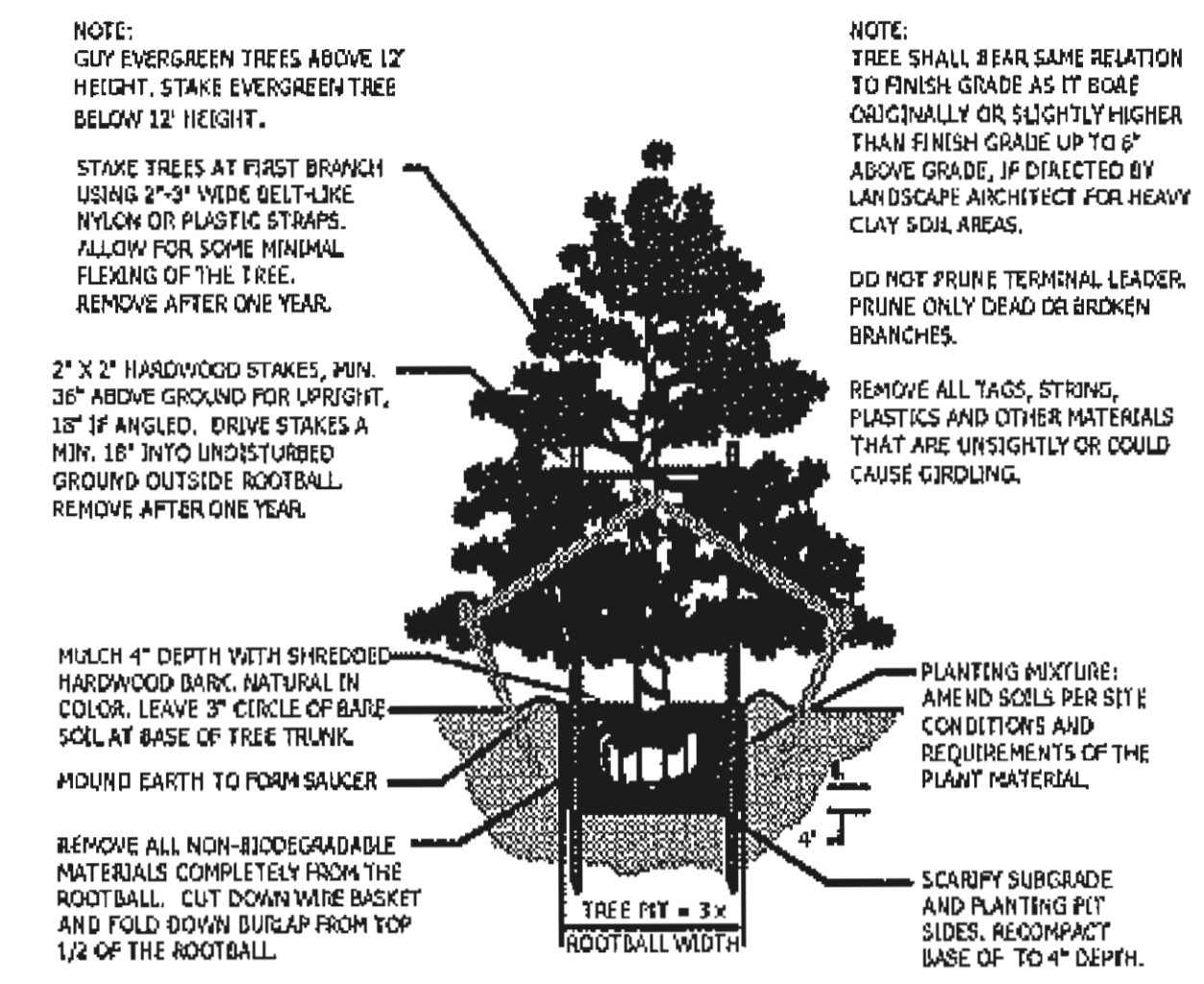

EVERGREEN TREE PLANTING DETAIL

CITY OF NOVI LANDSCAPE NOTES:

1. ALL PLANT MATERIALS ARE TO BE INSTALLED IN A SOUND, WORKMAN-LIKE MANNER AND IN ACCORDANCE WITH THE CURRENT CITY OF NOVI PLANTING REQUIREMENTS.
2. ALL PLANT MATERIALS SHALL BE INSTALLED BETWEEN MARCH 15th AND NOVEMBER 15th.
3. ALL PLANT MATERIALS ARE TO BE NORTHERN NURSERY GROWN NO. 1 GRADE AND INSTALLED ACCORDING TO ACCEPTED PLANTING PROCEDURES. ALL PLANT MATERIALS SHALL CONFORM TO THE CURRENT AAH STANDARDS FOR NURSERY STOCK. THEY SHALL BE PLANTED ACCORDING TO THE CITY OF NOVI PLANTING DETAILS AND SPECIFICATIONS. THE CITY SHALL HAVE THE RIGHT TO INSPECT THE PLANT MATERIALS PRIOR TO PLANTING AND TO REJECT ANY PLANT MATERIALS DEEMED NOT TO MEET THE STANDARDS OF THE ZONING ORDINANCE.
4. ALL TREES SHALL HAVE A CENTRAL LEADER AND A RADIAL BRANCHING STRUCTURE. PARK GRADE TREES ARE NOT ACCEPTABLE. ALL TREES SHALL BE BALLED AND BURLAPPED (B&B).
5. ANY DECIDUOUS CANOPY TREES WITH BRANCHES THAT MIGHT TEND TO DEVELOP INTO "V" CROTCHES SHALL BE SUBORDINATED SO AS NOT TO BECOME DOMINANT BRANCHES.
6. MULCH SHALL BE NATURAL COLOR, FINELY SHREDDED HARDWOOD BARK FOR ALL PLANTINGS. 4" THICK FOR TREES IN 4-FOOT DIAMETER CIRCLE WITH 3" PULLED AWAY FROM TRUNK. 3" THICK FOR SHRUBS AND SHRUB BEDS AND 2" THICK BARK FOR PERENNIALS.
7. ALL PLANT MATERIAL SHALL BE WARRANTED FOR TWO (2) FULL YEARS AFTER DATE OF ACCEPTANCE BY THE CITY OF NOVI. ALL UNHEALTHY AND DEAD MATERIAL SHALL BE REPLACED WITHIN ONE (1) YEAR OR THE NEXT APPROPRIATE PLANTING PERIOD WHICH EVER COMES FIRST.
8. ALL PLANT MATERIAL SHALL BE MAINTAINED IN A HEALTHY GROWING CONDITION, INCLUDING WATERING, CULTIVATION, WEED CONTROL AND SOIL ENRICHMENTS AS MAY BE NECESSARY.
9. A MINIMUM OF ONE WEED CONTROL CULTIVATION PER MONTH OCCURRING IN JUNE, JULY AND AUGUST SHALL BE PERFORMED DURING THE TWO-YEAR ESTABLISHMENT PERIOD.
10. ANY SUBSTITUTIONS OR DEVIATIONS FROM THE LANDSCAPE PLAN MUST BE APPROVED IN WRITING BY THE CITY OF NOVI PRIOR TO INSTALLATION.
11. ALL TREE WRAP, STAKES, AND GUYS MUST BE REMOVED BY JULY 1ST FOLLOWING THE FIRST WINTER SEASON AFTER INSTALLATION.
12. ALL LANDSCAPE AREAS ARE TO BE MAINTAINED IN HEALTHY GROWING CONDITION FREE OF DEBRIS AND REFUSE AND IN CONFORMANCE WITH THE APPROVED LANDSCAPE PLAN.
13. ALL LANDSCAPE AREAS ARE TO BE WATERED BY A FULLY AUTOMATIC IRRIGATION SYSTEM.
14. CONTRACTOR TO REMOVE ALL CONSTRUCTION DEBRIS AND EXCESS MATERIALS FROM THE SITE PRIOR TO FINAL ACCEPTANCE.
15. PLANT MATERIALS, EXCEPT SOIL, GROUND COVERS, AND CREEPING VINE TYPE PLANTINGS, SHALL NOT BE LOCATED WITHIN FOUR (4) FEET OF THE PROPERTY LINE.
16. ALL TRANSFORMERS ARE TO BE SCREENED ON THREE SIDES (MIN.) IN ACCORDANCE WITH THE CITY OF NOVI ORDINANCE AND SO AS TO NOT CONFLICT WITH DTE RESTRICTIONS. (SEE DETAIL THIS SHEET).
17. ALL BERMS MUST BE PLANTED WITH A COMBINATION OF TREES, SHRUBS, SOIL OR OTHER EVERGREEN GROUND COVERS.
18. THE OWNER IS RESPONSIBLE FOR REQUEST OF FINAL INSPECTION AND ACCEPTANCE OF THE LANDSCAPE AT THE END OF THE 2-YEAR GUARANTEE PERIOD.
19. THE PROVIDER OF THE FINANCIAL GUARANTEE FOR THE LANDSCAPE INSTALLATION SHALL BE FULLY RESPONSIBLE FOR COMPLETION OF THE LANDSCAPE INSTALLATION AND MAINTENANCE PER THE APPROVED LANDSCAPE PLAN AND APPLICABLE CITY ORDINANCES.

THE DETAILS AND NOTES SHOWN ON THIS PAGE ARE STANDARDS. THESE DETAILS ARE NOT ALL INCLUSIVE AND ARE NOT MEANT TO SUBSTITUTE FOR ANY ORDINANCE OR CODE REQUIREMENT. FOR COMPLETE LANDSCAPE REQUIREMENTS, SEE THE ZONING ORDINANCE LANDSCAPE SECTION 2509, THE LANDSCAPE DESIGN MANUAL AND THE APPROPRIATE REFERENCES WITHIN THE APPLICABLE ZONING CLASSIFICATION AND ANY OTHER APPLICABLE CODE REQUIREMENTS.



CITY OF NOVI STANDARD
LANDSCAPE DETAILS

SCALE:

DATE: 08-01-06

REVISIONS:

SHEET:

LD-1

DATE: 08-01-06

